

大西洋热盐环流多百年际振荡与人类文明演变史

Self-Sustained Multi-Centennial Oscillation of Atlantic Thermohaline Circulation

YANG Haijun (杨海军)^{1,2}, LI Yang (李洋)² and YANG Kunpeng (杨昆鹏)¹

¹Department of Atmospheric and Oceanic Sciences, Fudan University

²LaCOAS and Department of Atmospheric and Oceanic Sciences

School of Physics, Peking University

Email: yanghj@fudan.edu.cn



Our Questions

500±300 Years

1. *Natural Centennial-Millennial oscillation* in climate system?
地球气候系统是否存在百年-千年尺度自然振荡？
2. Connection to the *evolution of human civilization*?
这种振荡与人类文明演化是否有关系？

Background: Stable Holocene Climate

- Holocene: Since 10ka
- Stable external forcing
- Natural variability
(500±300) (?) years

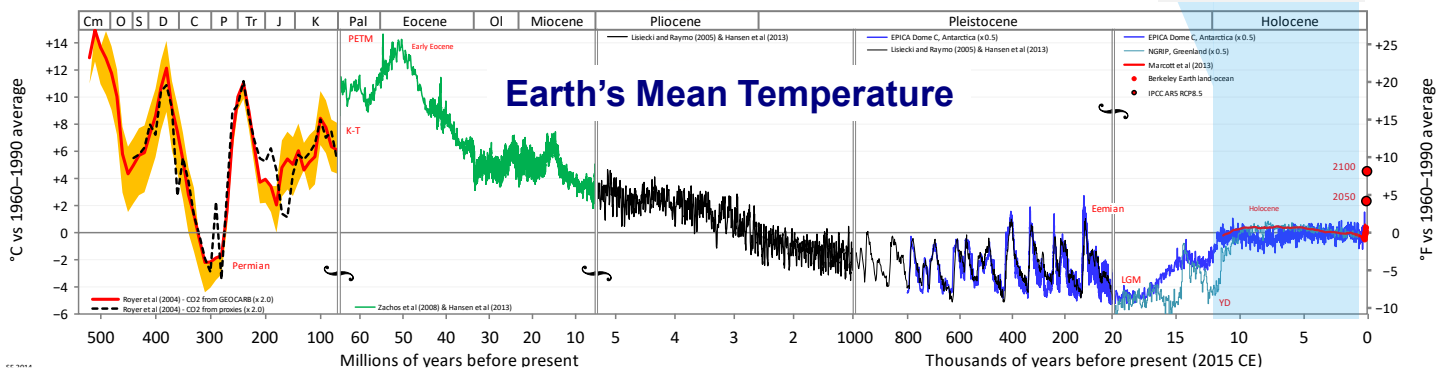
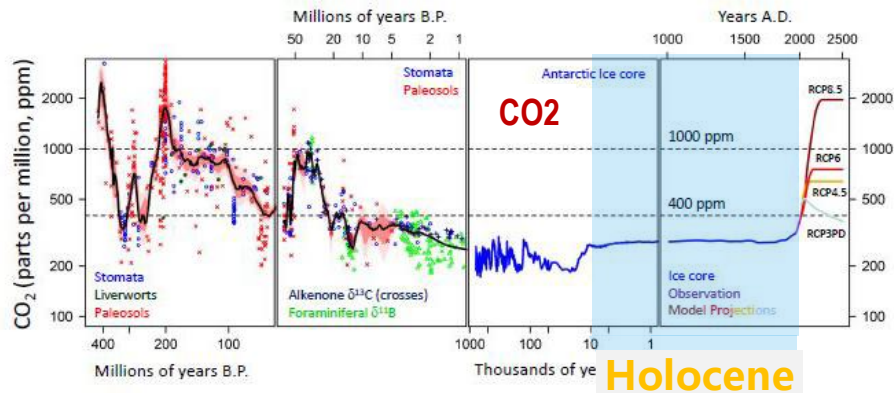

https://earth.org/data_visualization/a-brief-history-of-co2/



Background: Timescales of Climate Variabilities

Spectrum of Earth's Climate Variability

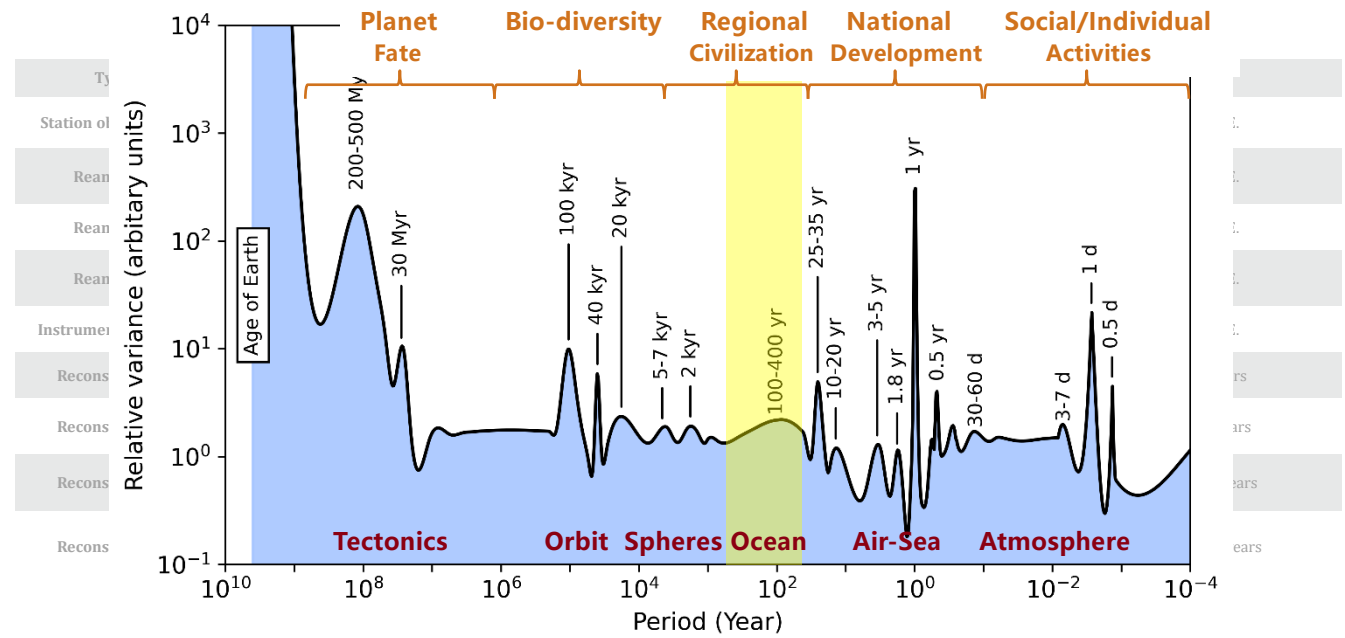

Based on multiply sources of “prewhitened” temperature records

Mitchell, 1976; Stocker and Mysak, 1992; Ghil, 2001; Heydt, 2021;



Contents

1. Motivation
2. Observations and Modeling Results
3. Theory
4. Our Modelings

Motivation

Earlier in **2013**, we confused ...

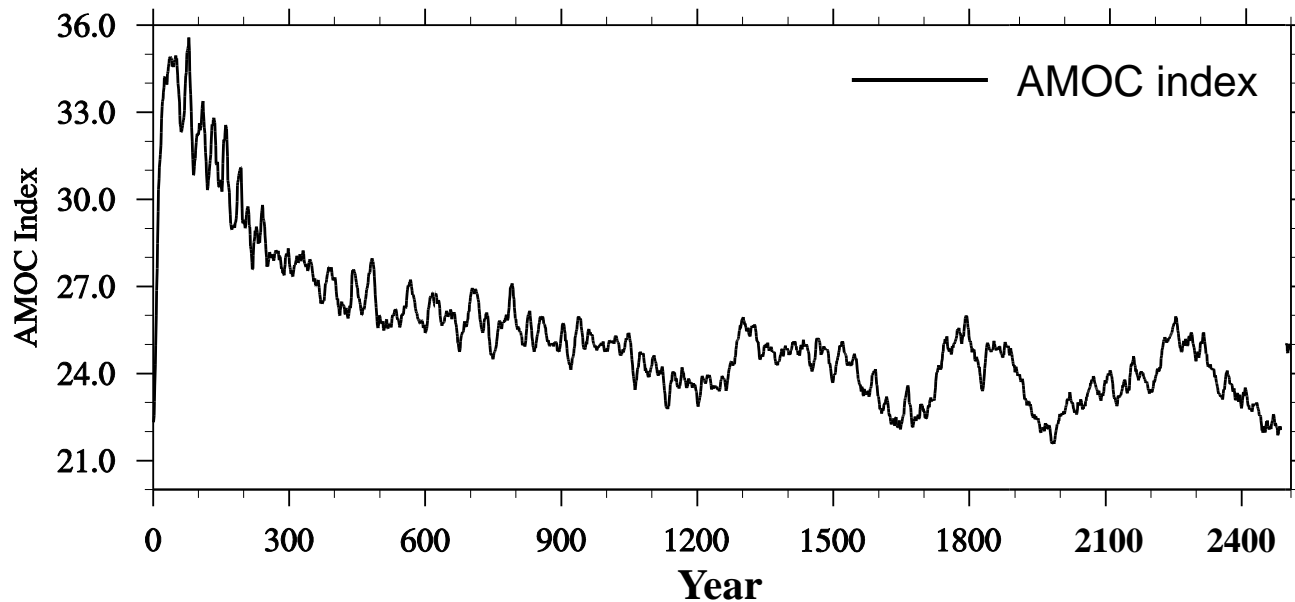

2500 years control run using **NCAR-CESM1.0**

Sea Ice → AMOC ?

Excellent correlation, but *causality?*

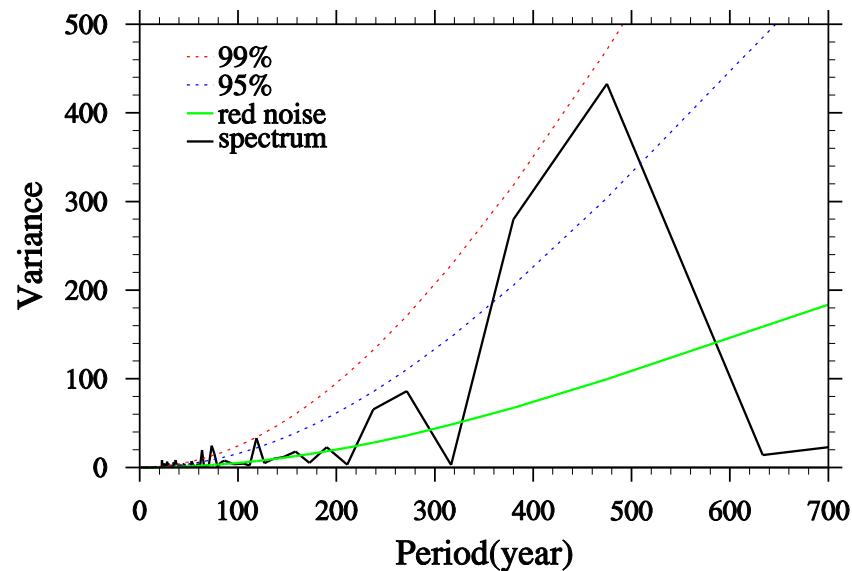
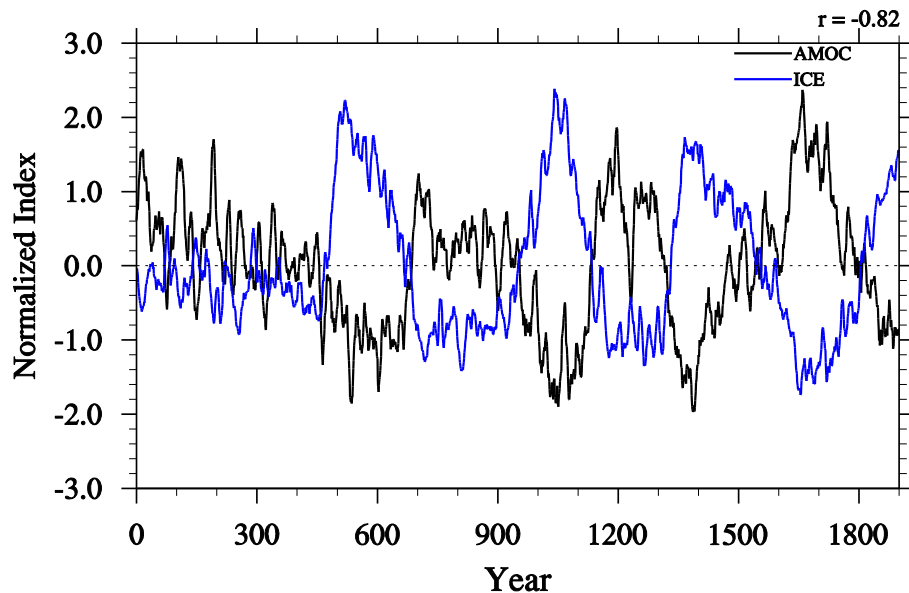

Confused ... So in 2018, We decided to decipher this mystery!

Contents

1. Motivation
- 2. Observations and Modeling Results**
3. Theory
4. Our Modelings

Observation: *Multicentennial* Variability in **Holocene**

Holocene Proxy: *Locations* and *timescale* represented

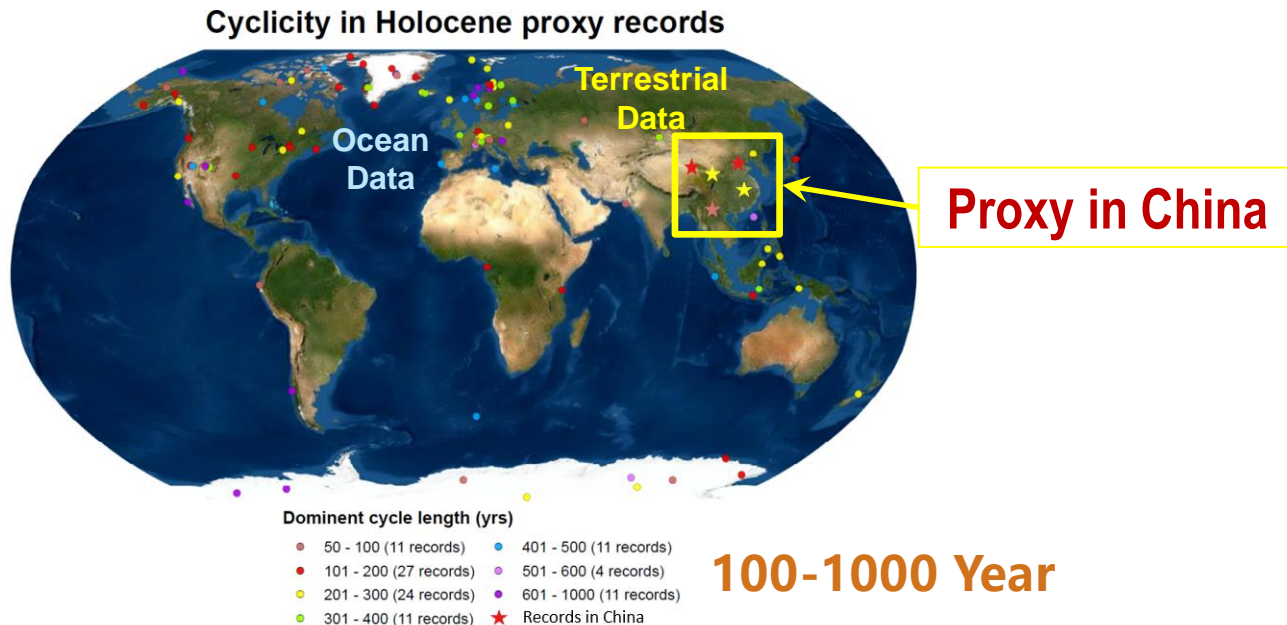

Thomas Gravgaard Askær et al., 2022: Multi-centennial Holocene Climate Variability in Proxy Records and Transient Model Simulations, QSR, 296 107801.

Observation: *Multicentennial* Variability in Holocene

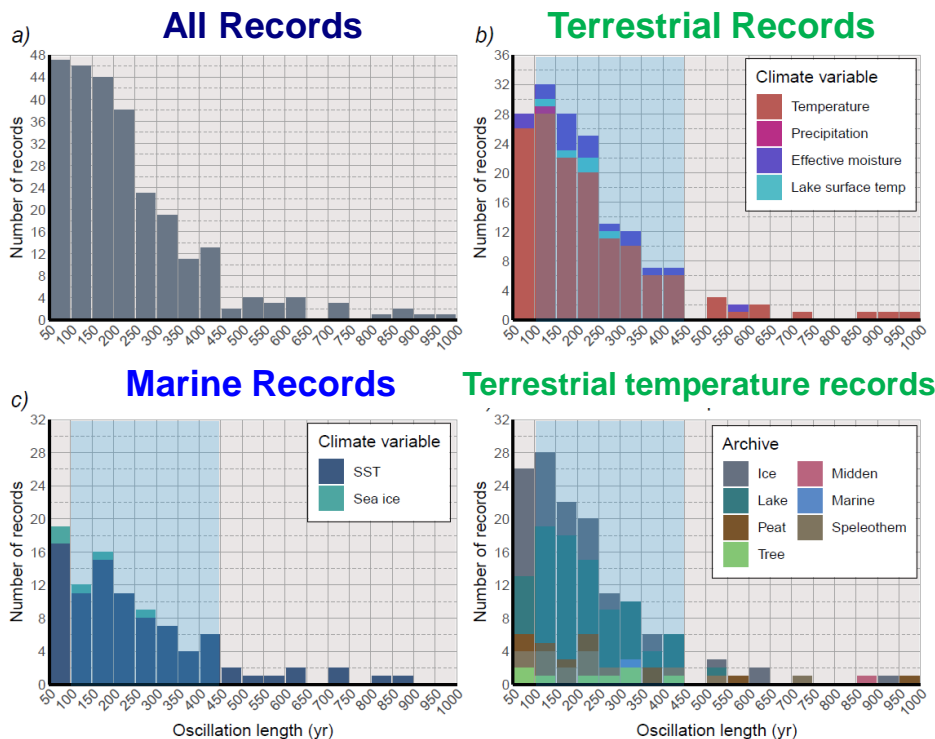

Thomas Gravgard Askær et al., 2022: Multi-centennial Holocene Climate Variability in Proxy Records and Transient Model Simulations, QSR, submitted.



Multicentennial Variability in Proxy and Coupled Models

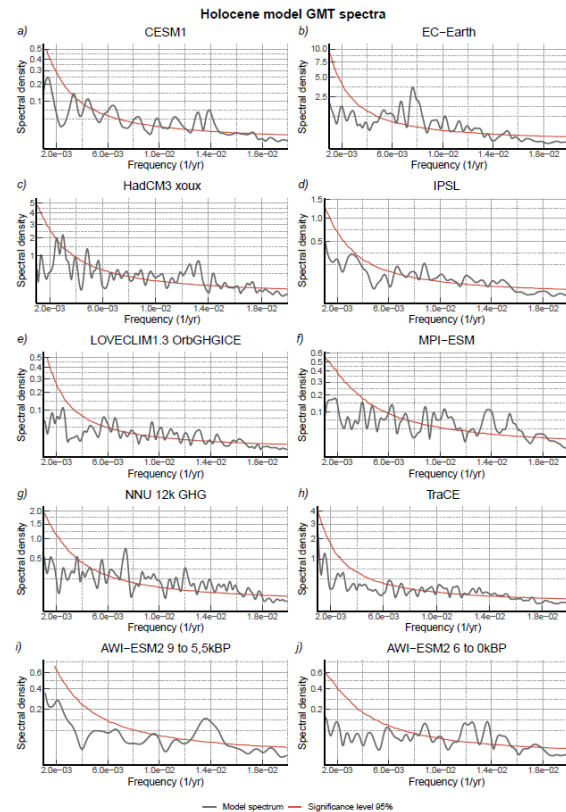
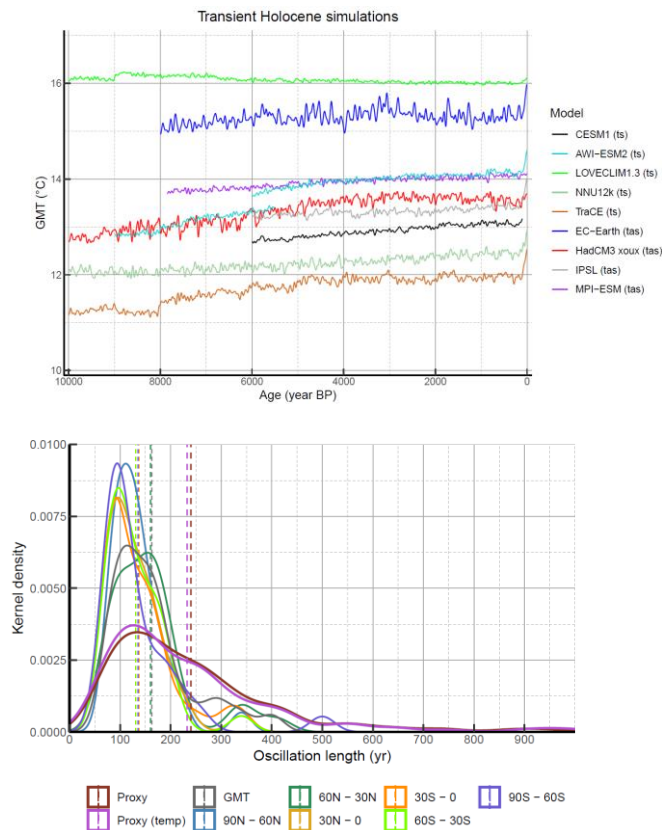

Thomas Gravgaard Askær et al. (2022), QSR



Centennial Variability: 200-300 (?) Years

文献出处	位置	代用指标	周期(年)
Siren et al., 1961 Lamb et al., 1977	拉普兰德	树轮	70,90,200
Soutar and Isaacs., 1969	加利福尼亚	海底沉积物	106,170,360
Johnsen and Dansgaard, 1970	格陵兰	冰芯	53-56,69-73,104- 144,160-185
LaMarche et al., 1974	美国内华达州	树轮宽度	70,110
Schweingruber et al., 1976	瑞士	树轮宽度	30,120
Lamb et al., 1977	英国, 俄罗斯	冬天严寒程度	300, 100
Nefel et al., 1981 Sonett et al., 1984	加利福尼亚	树轮中的 C 放射	150-300, 160,200
Fisher et al., 1982	格陵兰- 加拿大	冰芯	170-185,300-330,147- 435,625-714
Hameed et al., 1983	中国北京	降水记录	56,84,126
Thompson et al., 1989	秘鲁安第斯山脉	冰芯	110,250
Gajewski, 1988	Hells Kitchen 湖(美 国威斯康辛州)	湖底沉积物中的花粉	90-120, 230-250
Stuiver and Braziunas., 1989	/	树轮中的 14C	45,52,67, 143,218,420
Rothlisberger et al., 1989	/	树轮和冰川振荡	88,102-104,123-143

文献出处	位置	代用指标	周期(年)
Briffa et al., 1990	Fennoscandia	树轮	50-150
Anklin et al., 1998	格陵兰岛	冰川雪和冰芯	100,200
Chapman and Shackleton., 2000	北大西洋	深海沉积物	550
McDermott et al., 2001	爱尔兰西南部	/	78,169,625
Proctor et al., 2002	苏格兰西北部	石笋	72-96,116-150
Nyberg et al., 2002	加勒比东北部	有孔虫	200-400
Risebrobakken et al., 2003	挪威海	岩芯	80-115,260, 417,550-570
Oppo et al., 2003	大西洋东北部	有孔虫	百年
Sicre et al., 2008	冰岛北部	冰芯	50-150
J. Zheng et al., 2010	中国东部、西部、青 藏高原	历史文献、树轮、 降水	200-300 百年
Perner et al., 2013	格陵兰西部	有孔虫	百年
Newby et al., 2014	北美洲	湖底沉积物	几百年
Thirumalai et al., 2018	Garrison 海盆	有孔虫	百年

杨海军, 石佳琪等, 2023: 多百年际气候变率: 观测、理论与模拟研究. 科学通报, 待刊.



Centennial Variability in *Proxy* Data

Lapland
Tree rings width

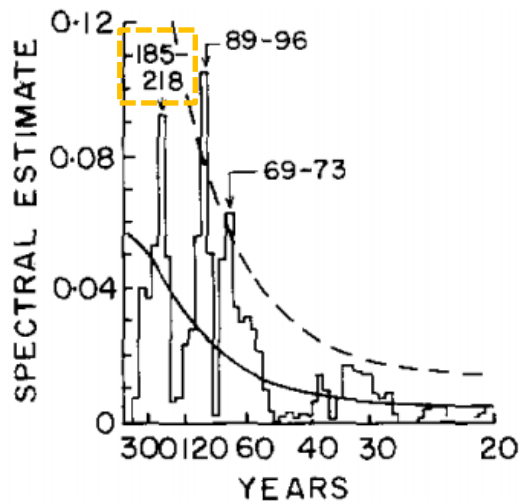

Santa Barbara Basin sediment
minimum population of hake

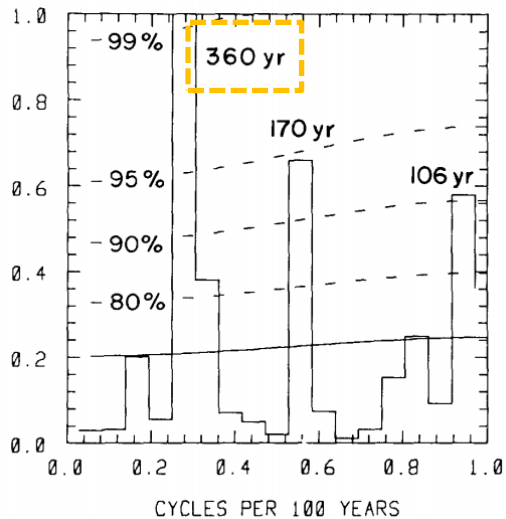

Camp Century
Cores (氧同位素)

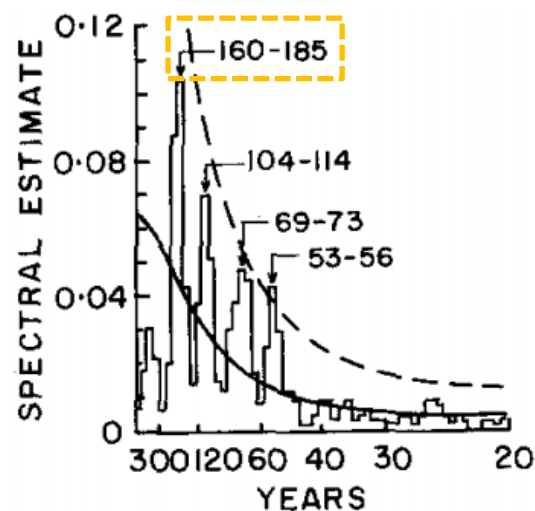

Siren et al. (1961), Lamb et al. (1977); Soutar and Issacs (1969); Johnsen and Dansgaard (1970)



Centennial Variability in *Proxy* Data

(f) $\delta^{18}O_{foram}$ from P1003MC/SC

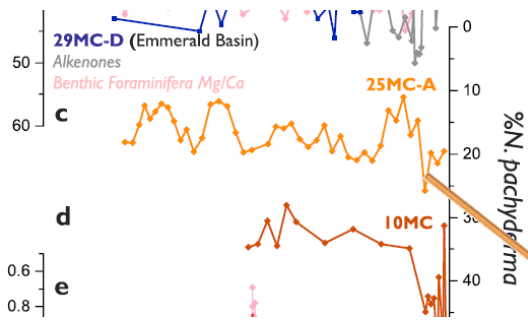
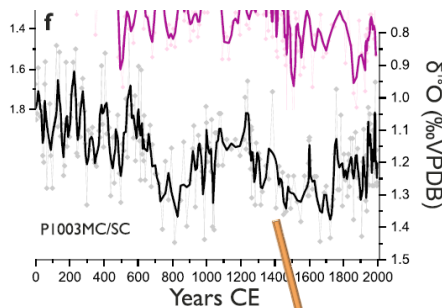

(c) % *N.pachyderma* from Laurentian Fan (25MC-A)

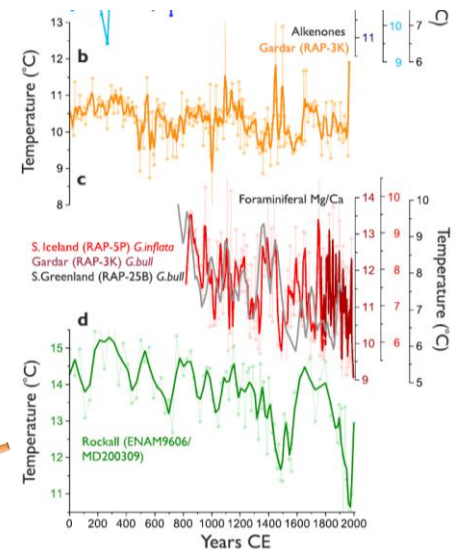
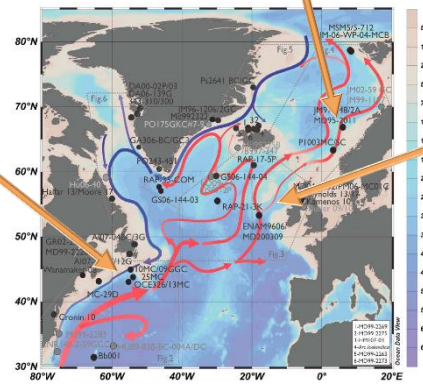

(b) alkenone records from RAPiD-21-3K; (d) foraminiferal Mg/Ca-based temperature reconstructions from Rockall Trough ENAM9606/M2003209

Moffa-Sánchez et al. (2019), Paleoceanography and Paleoclimatology



Chinese Scientists' contribution: Temperature evolution in eastern China in wintertime of the past 2000 years

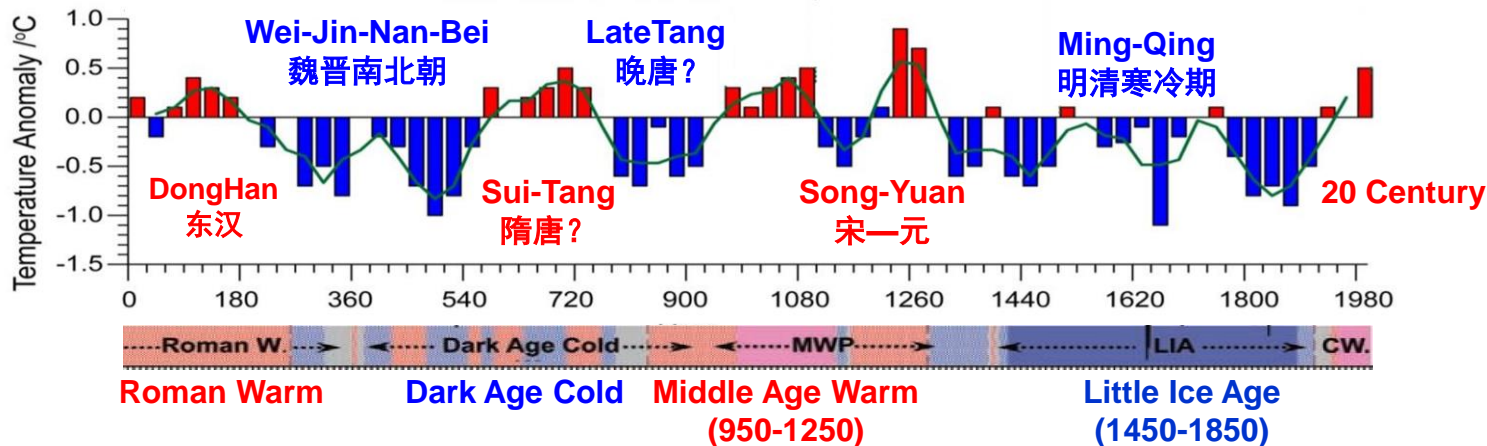

葛全胜, 郑景云, 满志敏, 方修琦, 张丕远, 2002: 过去2000a中国东部冬半年温度变化序列重建及初步分析. 地学前沿, 9(1), 169-181.

郑景云等, 2010; 葛全胜等, 2014

Documentary records in China: 200-300 or 600 (?) Years

Warm and Cold period during the past 5000 years in the evolution of civilization over greater China

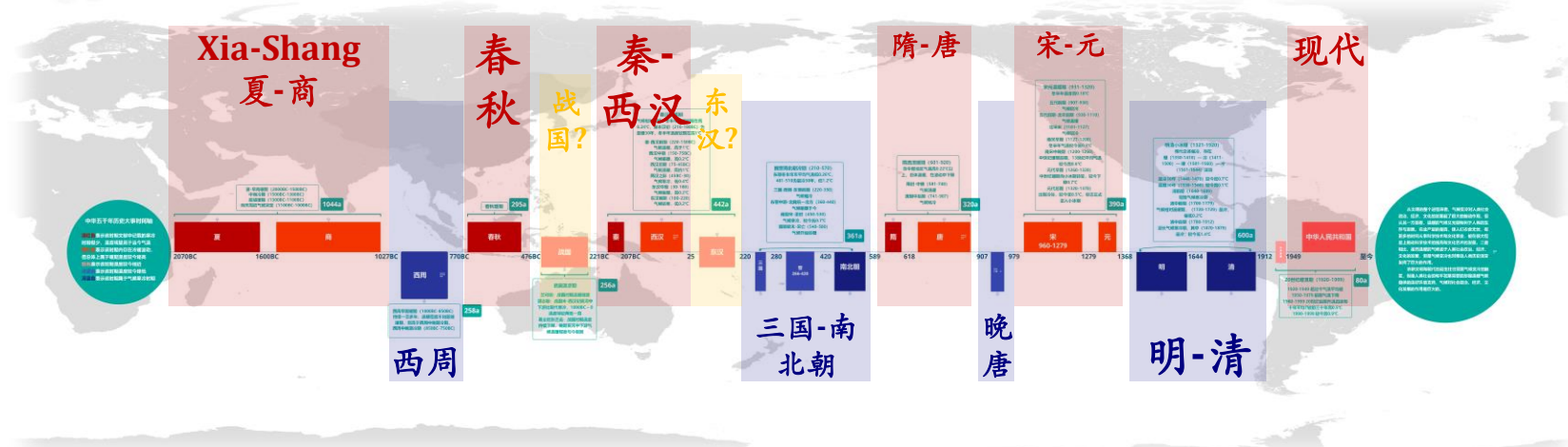

竺可桢, 1925: 南宋时代我国气候之揣测; 1961: 历史时代世界气候的波动; 1972: 中国近五千年气候变迁的初步研究
吴祥定等, 1990: 树木年轮与气候变化; 张丕远等, 1996: 中国历史气候变化; 牟重行, 1996: 中国五千年气候变迁的再考证
张德二等, 2004: 中国三千年气象记录总集; 满志敏, 2009: 中国历史时期气候变化研究

<https://corp.fudan.edu.cn/Reading/气候如何影响人类文明兴衰.pdf>
https://mp.weixin.qq.com/s/OU4YXCc_PYKJv5xuZbvYkQ



人类文明的兴衰史也与百年-千年的气候振荡有密切关系

诺亚方舟

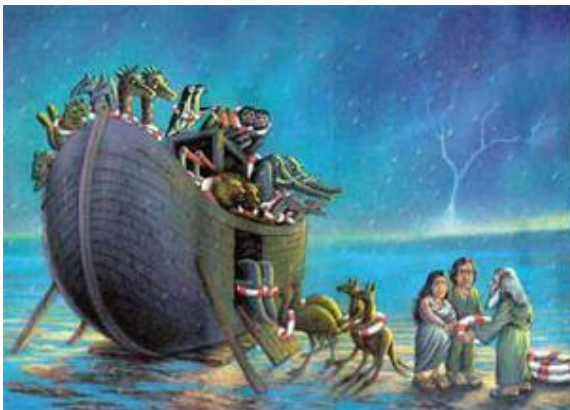

大禹治水

- 王绍武 (2005a) : 公元前2.2-2千年尼罗河文明、两河流域文明及印度河文明等等突然衰落发生在中纬度普遍变冷的气候背景中, 是全新世进入大暖期以来的一次强冷事件
- 王绍武 (2005b) : 洪水→干旱→中华文明的诞生→公元前2070年夏朝建立
- 王绍武和黄建斌 (2006) : 夏朝建立的基础“大禹治水”, 气候干旱可能对“治水”成功产生了影响
- 王绍武等 (2011) : 距今6-4千年的五帝时代: 湿润→干旱; 可能与热盐环流的突然减弱有关

Our Questions

500±300 Years

1. *Natural Centennial-Millennial oscillation* in climate system?

地球气候系统是否存在百年-千年尺度自然振荡? (Yes!)



What component of the Earth's climate system can provide multicentennial timescale?

Great Conveyor Belt: *Thousands'* Years

AMOC

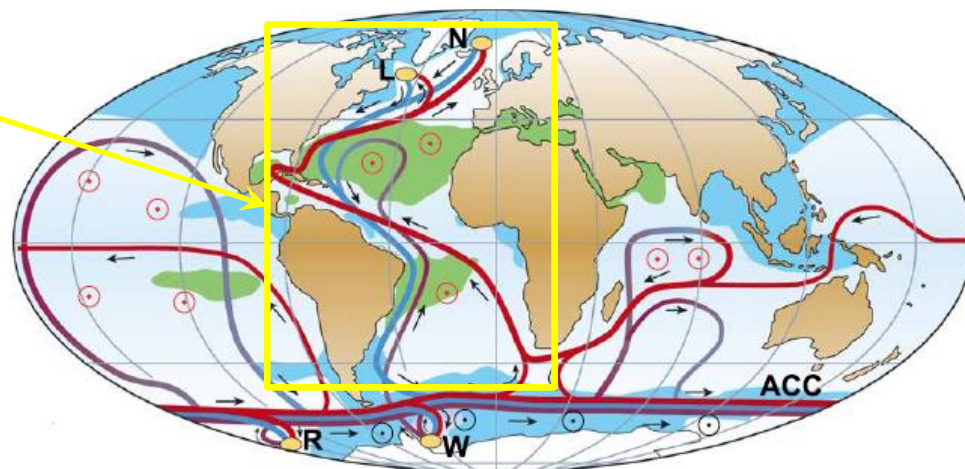

- | | | |
|----------------------|-------------------------|-----------------------|
| Surface flow | Wind-driven upwelling | L Labrador Sea |
| Deep flow | Mixing-driven upwelling | N Nordic Seas |
| Bottom flow | Salinity > 36 ‰ | W Weddell Sea |
| Deep Water Formation | Salinity < 34 ‰ | R Ross Sea |

Advection timescale: *Thousands'* years
→→ Timescale for *multicentennial variability*

AMO: 60-80 Years

Tons of studies on *decadal* (20-30 yr) & *multi-decadal* (60-80 yr) variabilities

No direct evidences of multicentennial variability

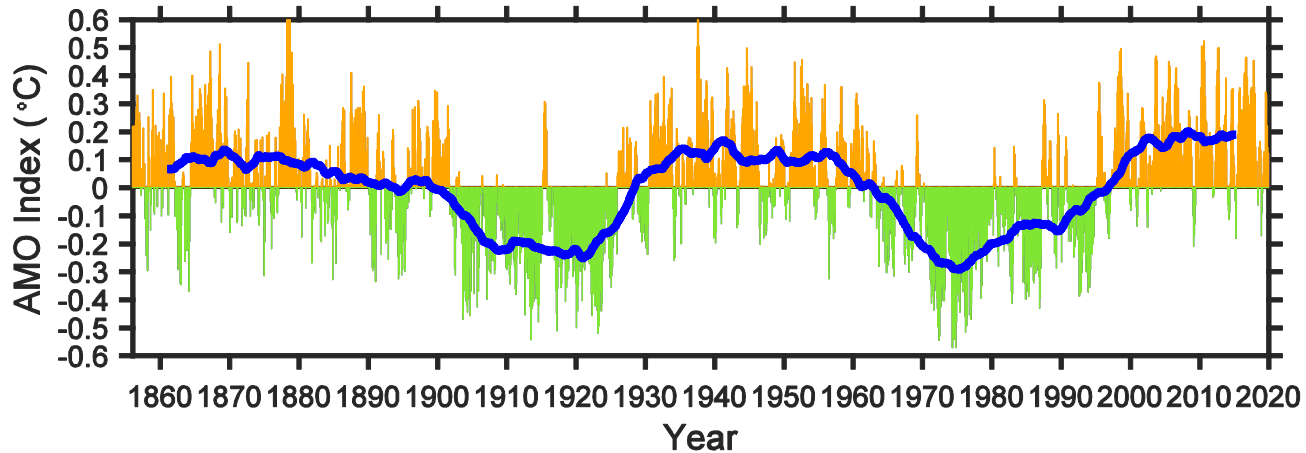

Kaplan SST (Kaplan et al., 1998; Drinkwater et al., 2014)

Centennial Oscillation in EC-Earth3 Model

2000 Years period PI control experiment

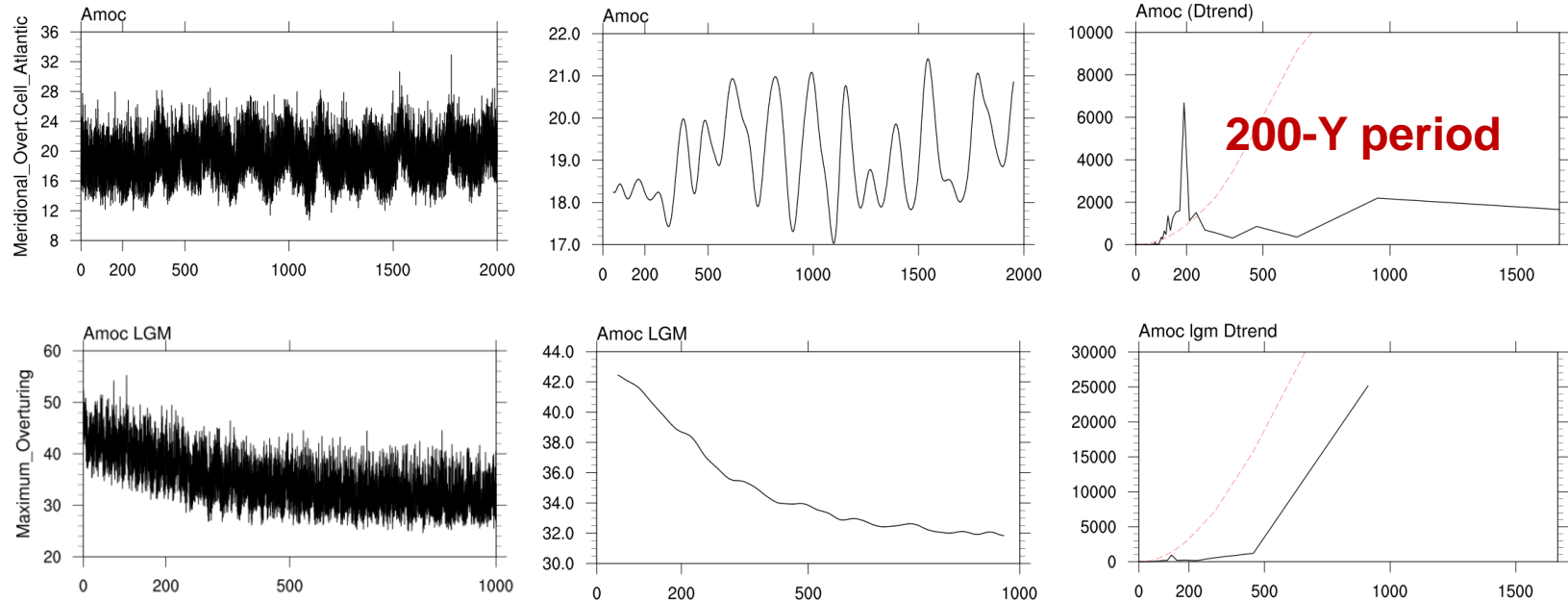

Zhang et al. (2021)



Exists also in Other Models ...

AMOC oscillations in the coupled PlaSim-LSG EMIC

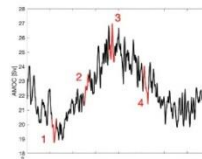
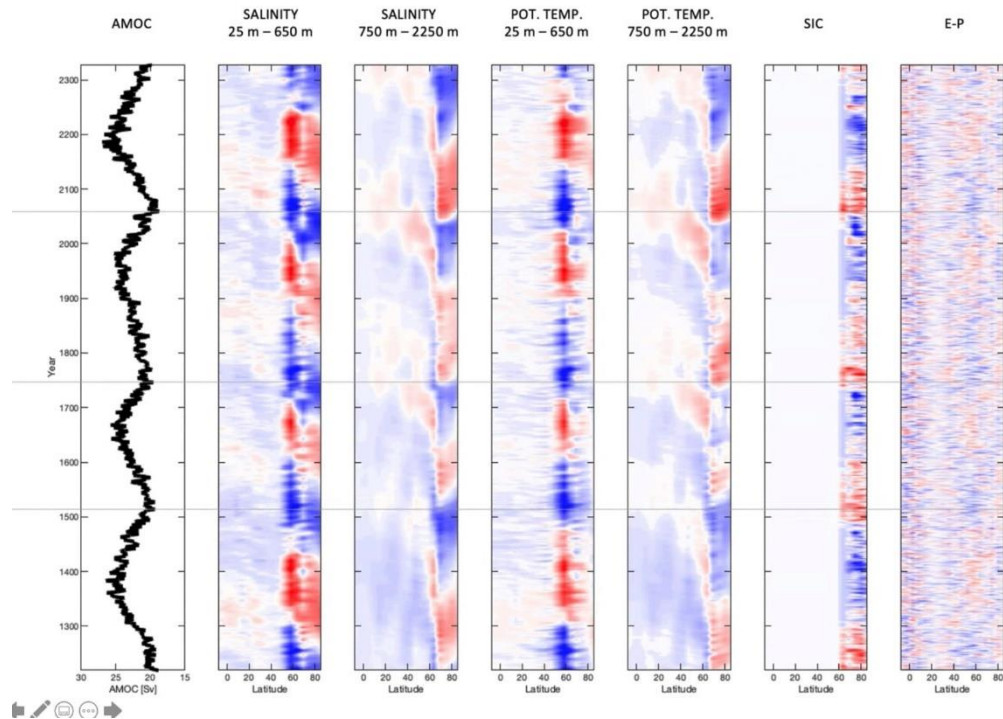

TIPES
TIPPING POINTS IN THE EARTH SYSTEM

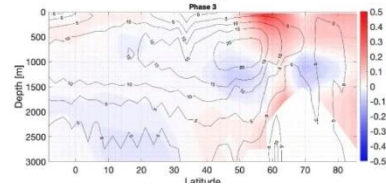
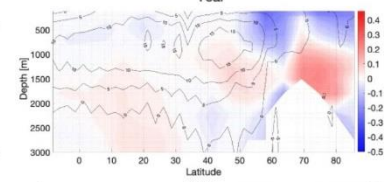
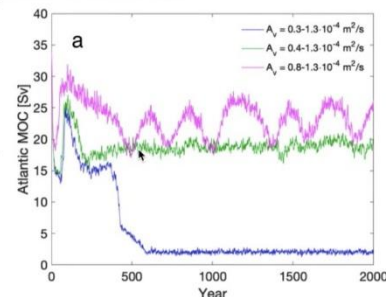

Angeloni et al. (2021)

Our Questions

500±300 Years

1. *Natural Centennial-Millennial oscillation* in climate system?

地球气候系统是否存在百年-千年尺度自然振荡? (Yes!)



2. Coupled Model: **AMOC** has multicentennial variability

→ Climate system



Why and How? **Theory needed!**

Contents

1. Motivation
2. Observation and Modeling
- 3. Theory, Simple Model: Previously**
4. Our Modelings

2-Box Model and Multi-Equilibrium

Thermohaline Convection with Two Stable Regimes of Flow

By HENRY STOMMEL, Pierce Hall, Harvard University, Massachusetts

(Manuscript received January 21, 1961)

Abstract

Free convection between two interconnected reservoirs, due to density differences maintained by heat and salt transfer to the reservoirs, is shown to occur sometimes in two different stable regimes, and may possibly be analogous to certain features of the oceanic circulation.

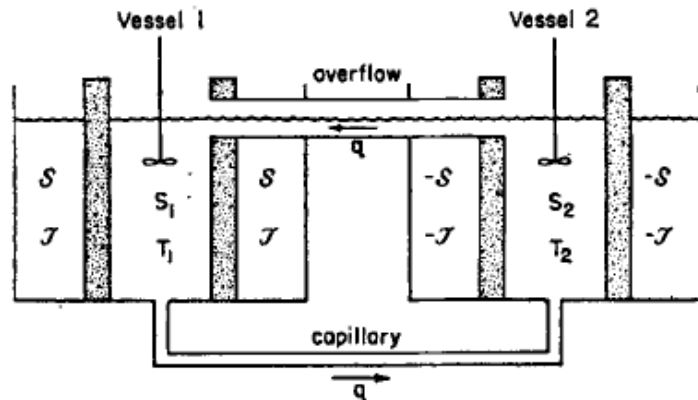

Henry Stommel (Tellus, 1961)

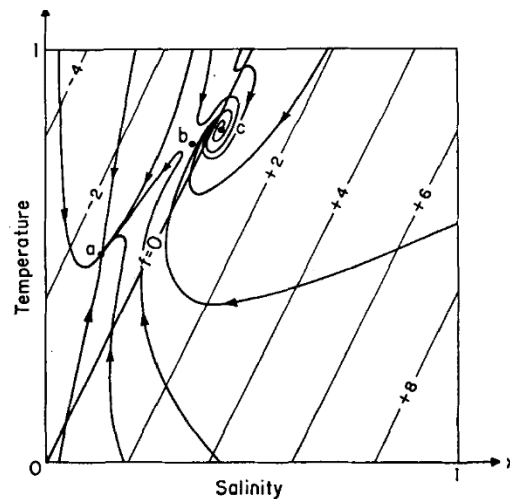

Energy Source: *Ocean Convection*

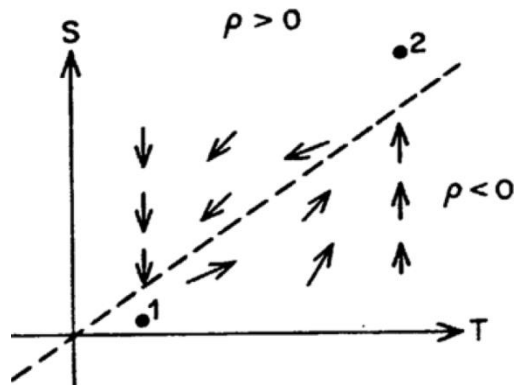
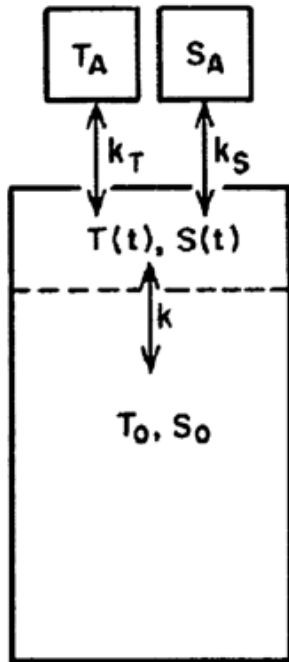

- *Flip-Flop model*
- **Self-sustained oscillation with increasing vertical turbulent mixing**

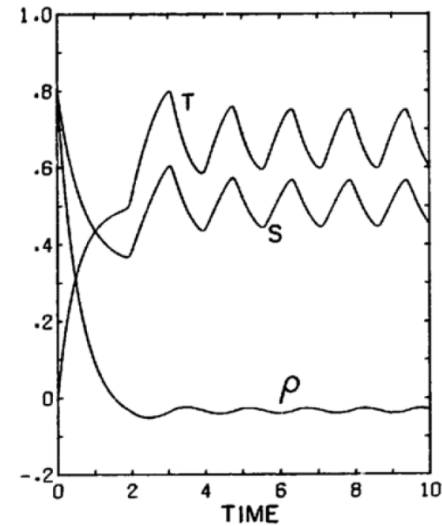

Pierre Welander (1982), A simple heat-salt oscillator. Dyn. Atmos. Oceans.

3-Box Model and Multi-Equilibrium

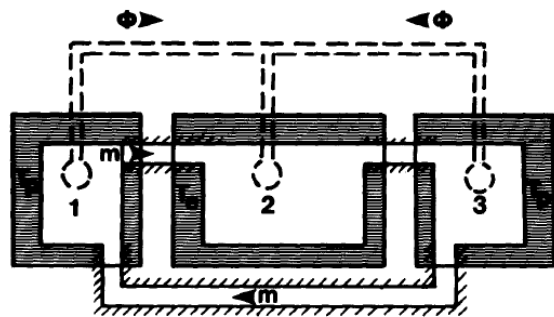

Claes Rooth (1982)

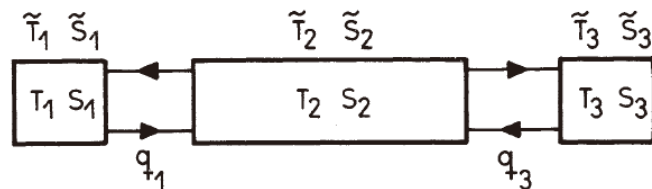

Pierre Welander (1986)

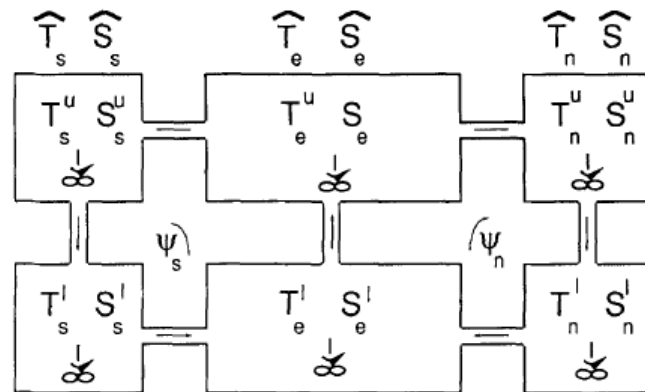

2D Model and 2-, 3-Box Model

Olivier Thual & James C. McWilliams (1992)

Climate transition between different stable regimes, with global and centennial-millennium timescale

Energy Source: *Atmosphere* Perturbation

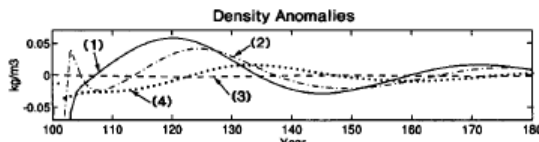
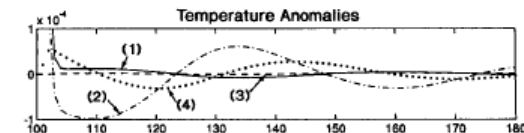
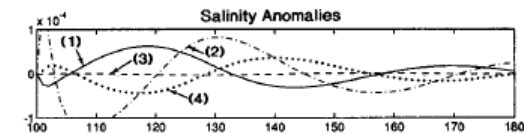
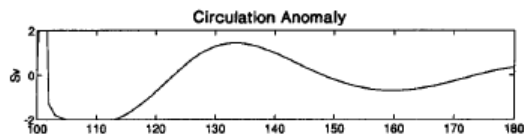

←: Damped Oscillation

Mode

Circulation under random thermal forcing →

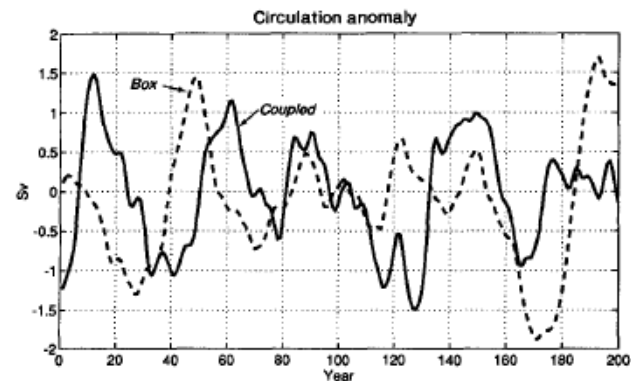

- 2-Box: Interdecadal variability of THC
- Linear interpretation
- Excited by atmospheric random forcing

Stephen Griffies and Eli Tziperman (1995): A linear thermohaline oscillator driven by stochastic atmospheric forcing. J. Climate

Energy Source: *Ocean Advection* Feedback

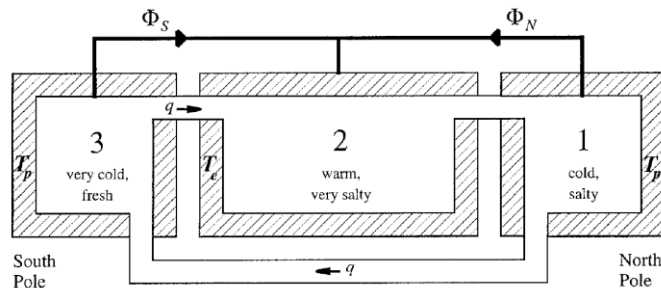
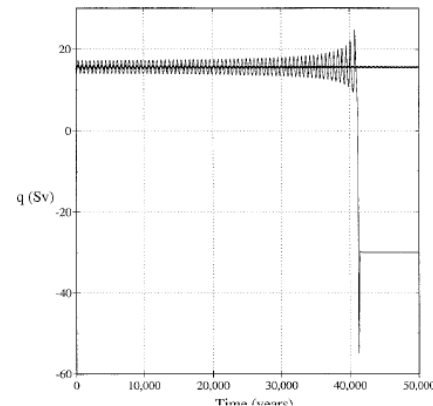
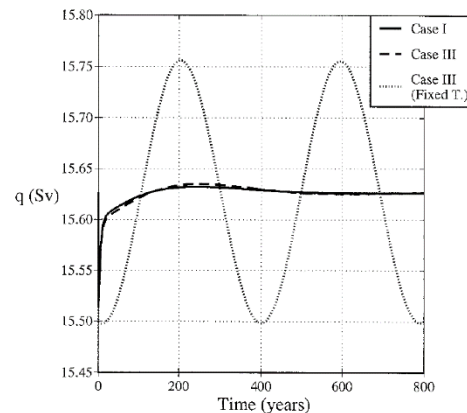

FIG. 1. Rooth's conceptual three-box model of thermohaline circulation, showing equilibrium conditions for Northern Hemisphere sinking. The separation between high- and low-latitude boxes is assumed to occur near the peak in atmospheric transports due to baroclinic eddy fluxes, i.e., about 35° latitude.



3-Box model with asymmetrical freshwater forcing / Stability of the equilibrium

Periodic oscillation with constant Temperature / Collapse under some parameters

Jeffery Scott, Jochem Marotzke and Peter Stone (1999): Interhemispheric thermohaline circulation in a coupled box model. JPO.

Single Equilibrium: *Self-Sustained Oscillation*

Self-sustained oscillation with nonlinear close condition

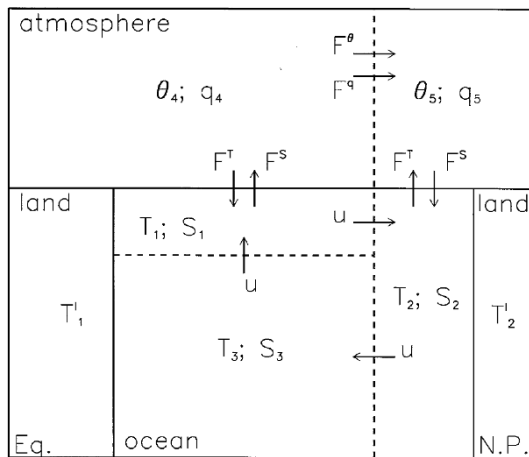
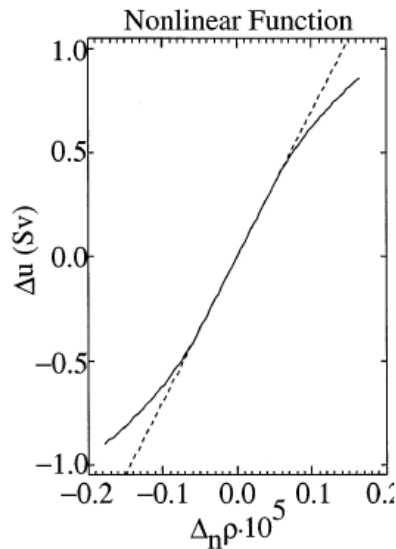

FIG. 1. The box model geometry.

3-Box coupled model



$$u = \bar{u} + u' = \bar{u} + \xi(u_0, \Delta_n \rho') \Delta_n \rho', \quad (2)$$

where

$$\xi(C, x) = \begin{cases} C \frac{x_+}{x} \left[k \left(\frac{x}{x_+} \right)^{1/k} - 1 \right] + 1 & \text{if } x > x_+ \\ C & \text{if } x_+ \geq x \geq x_- \\ C \frac{x_-}{x} \left[k \left(\frac{x}{x_-} \right)^{1/k} - 1 \right] + 1 & \text{if } x < x_- \end{cases} \quad (3)$$

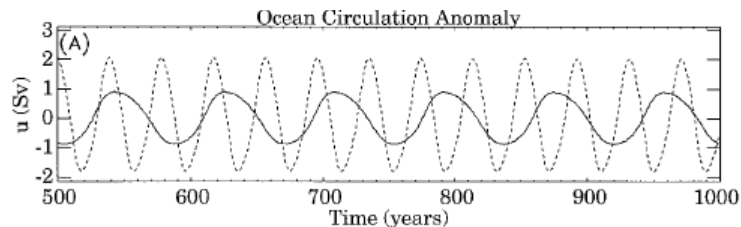

Rivin & Tziperman (1997): Linear versus self-sustained interdecadal thermohaline variability in a coupled box model. JPO

Multi-Equilibrium: *Forced Regime Shift*

Stommel 2-Box model, no *intrinsic* variability, stochastic forced variability

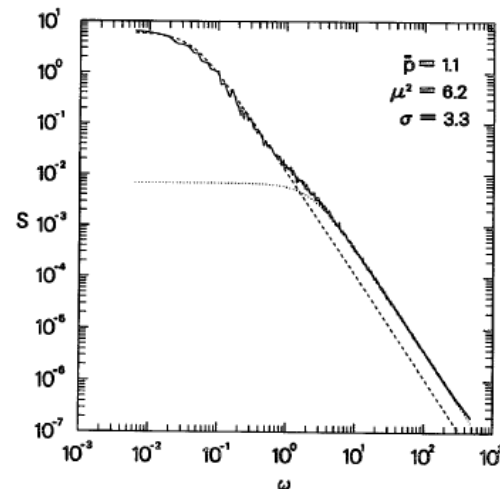
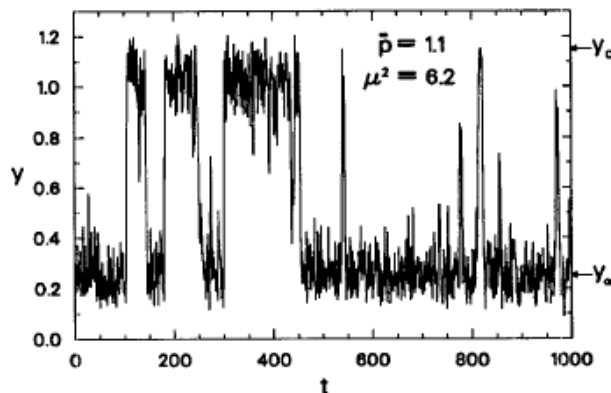
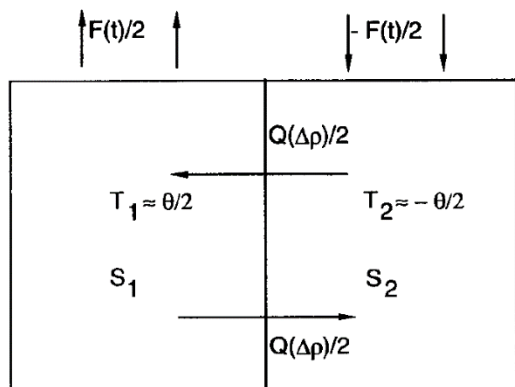

Middle: Multi-equilibrium and forced oscillation; Right: Power spectrum

Paola Cessi (1994), A simple box model of stochastically forced thermohaline flow. JPO

Single Equilibrium: *Forced Oscillation*

Atmosphere Lorenz model and Ocean 3-Box model

Lorenz (1984, 1990) introduced a low-order atmospheric "general circulation" model, defined by three ordinary differential equations:

$$\frac{dX}{dt} = -Y^2 - Z^2 - aX + aF, \quad (1)$$

$$\frac{dY}{dt} = XY - bXZ - Y + G, \quad (2)$$

$$\frac{dZ}{dt} = bXY + XZ - Z. \quad (3)$$

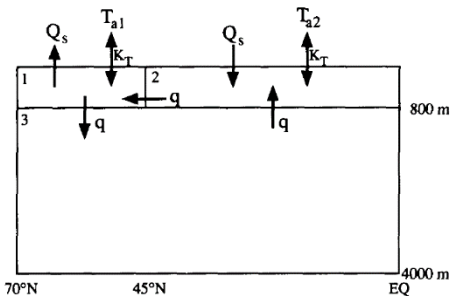

Coupled

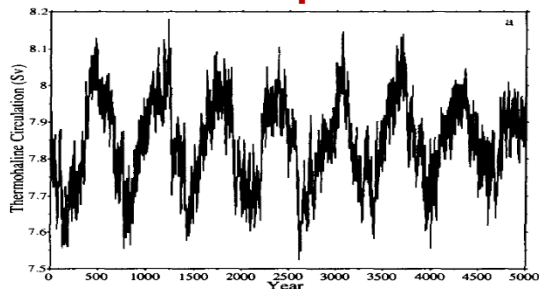

Uncoupled

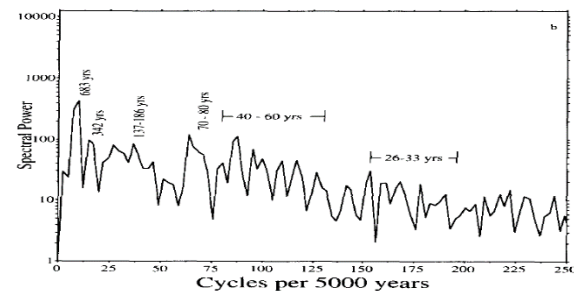
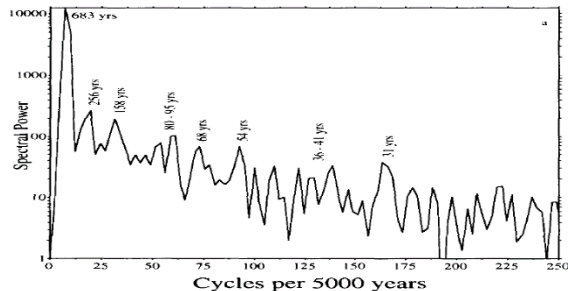
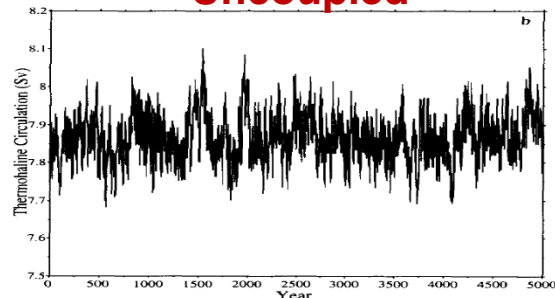

Paul Roebber (1995), Climate variability in a low-order coupled atmosphere-ocean model. Tellus-A

3-Box Model for Bond Cycle

A 3-Box with only Salinity considered, internal *Millennial* oscillation

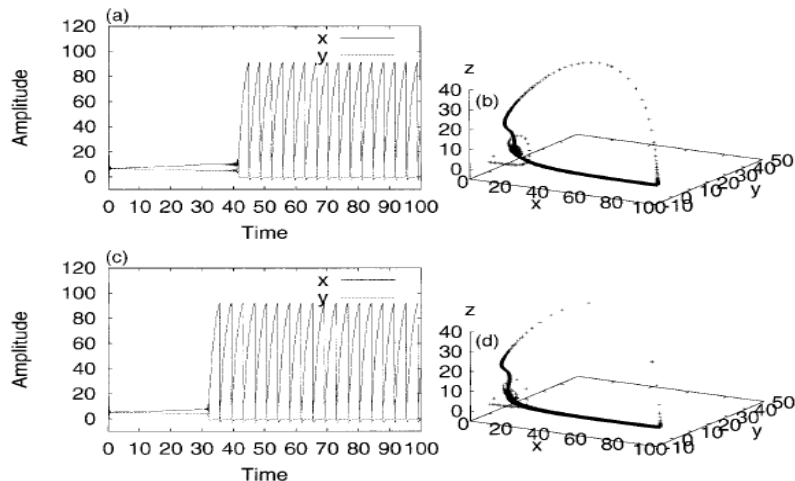
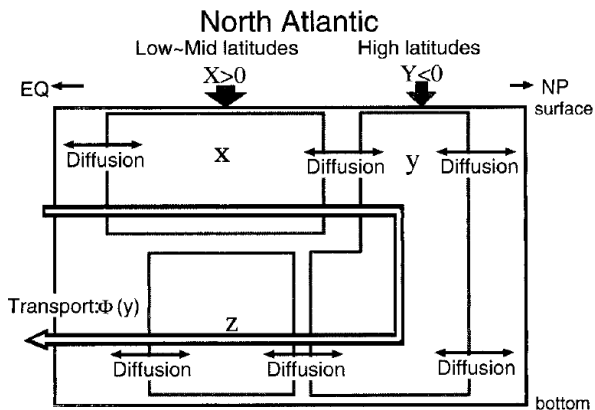

Bifurcation: from a stable solution to an unsteady bounded oscillation

Sakai & Peltier (1999), A dynamical systems model of the Dansgaard-Oeschger oscillation and the origin of the bond cycle. JC

Thermohaline Circulation Stability: *Regime Shift*

3-Box model, hysteresis behavior under freshwater forcing

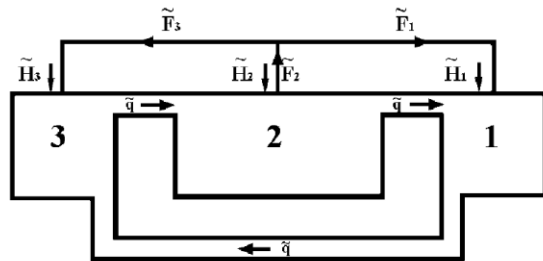
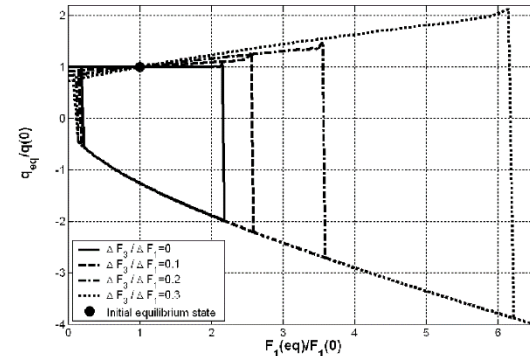
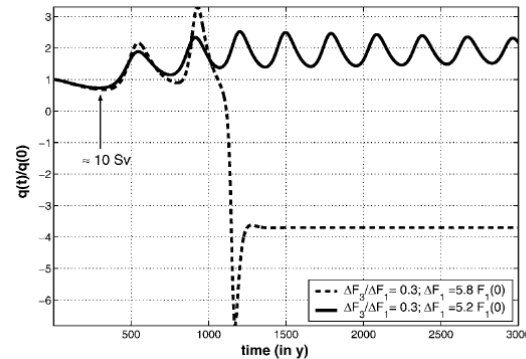

FIG. 1. Schematic picture of the interhemispheric box model.



Lucarini & Stone (2005), Thermohaline circulation stability: a box model study. Part I: uncoupled model. JC

Thermohaline Circulation Centennial Oscillation

2-D with random forcing, 200-300 years oscillation

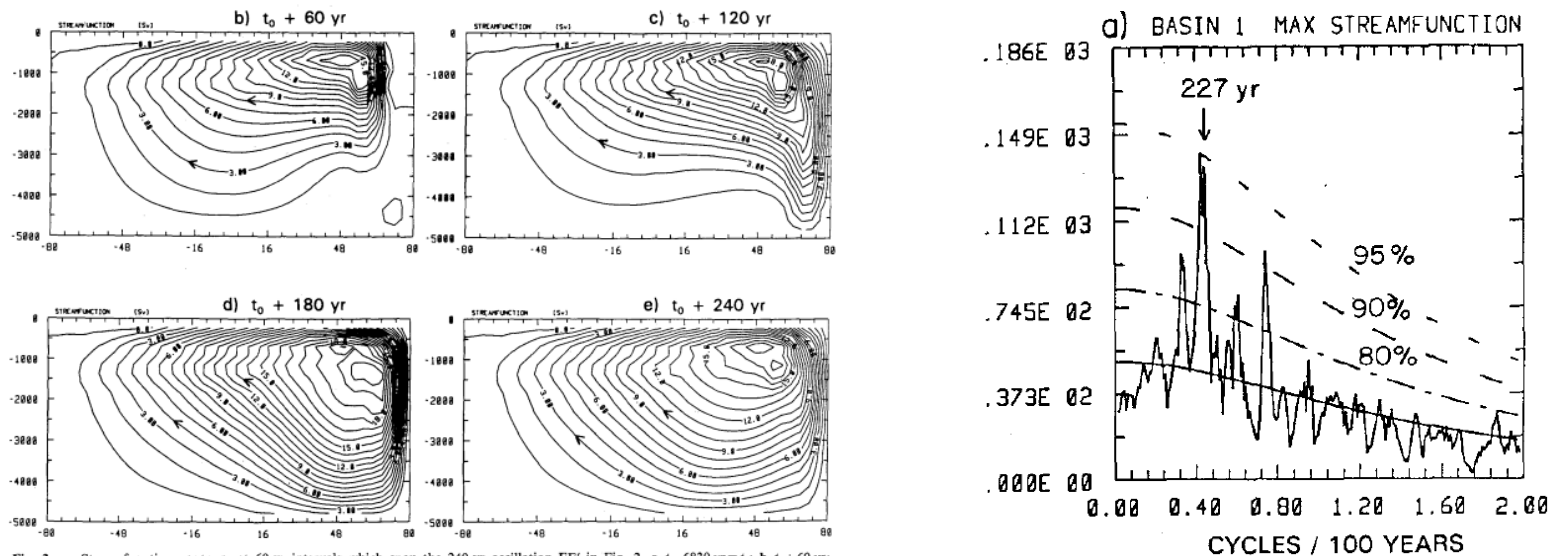

Fig. 3a-e. Streamfunction contours at 60-yr intervals which span the 240-yr oscillation EE' in Fig. 2. a $t = 6830 \text{ yr} = t_0$; b $t_0 + 60$ yr; c $t_0 + 120$ yr; d $t_0 + 180$ yr, and e $t_0 + 240$ yr (end of oscillation)

Period: 200-300 years of AMOC, Salinity advection feedback

Mysak et al., Climate Dynamics, 1993: Century-scale variability in a randomly forced, 2-D thermohaline ocean circulation model.

Energy Source: *Ocean Convection*

3-D OGCM with freshwater forcing, *centennial-millennial* oscillation

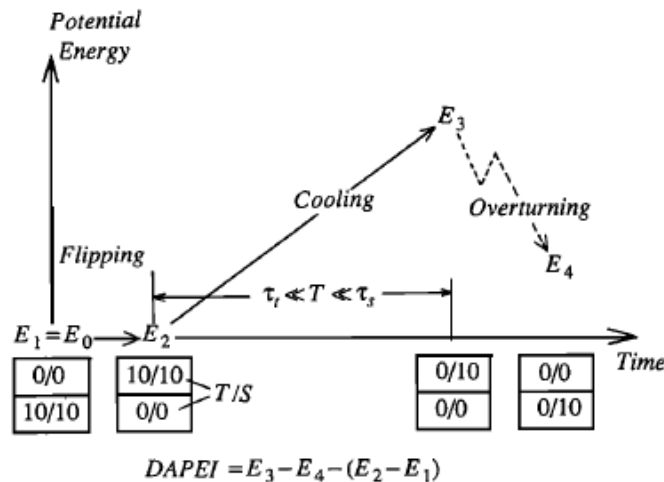
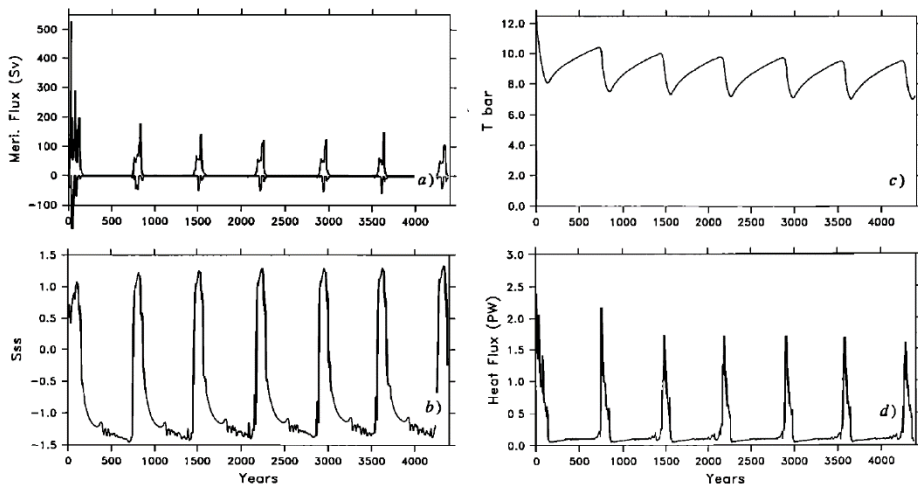

- **Periodic oscillation of saline mode**
- **DAPE provides energy to saline mode's oscillation**

Huang (1994): Thermohaline circulation: Energetics and variability in a single-hemisphere basin model. JGR-ocean

Multi-Equilibrium: *Self-Sustained Oscillation*

Late Permian, Equable climate and regime shift, *Millennial* oscillation

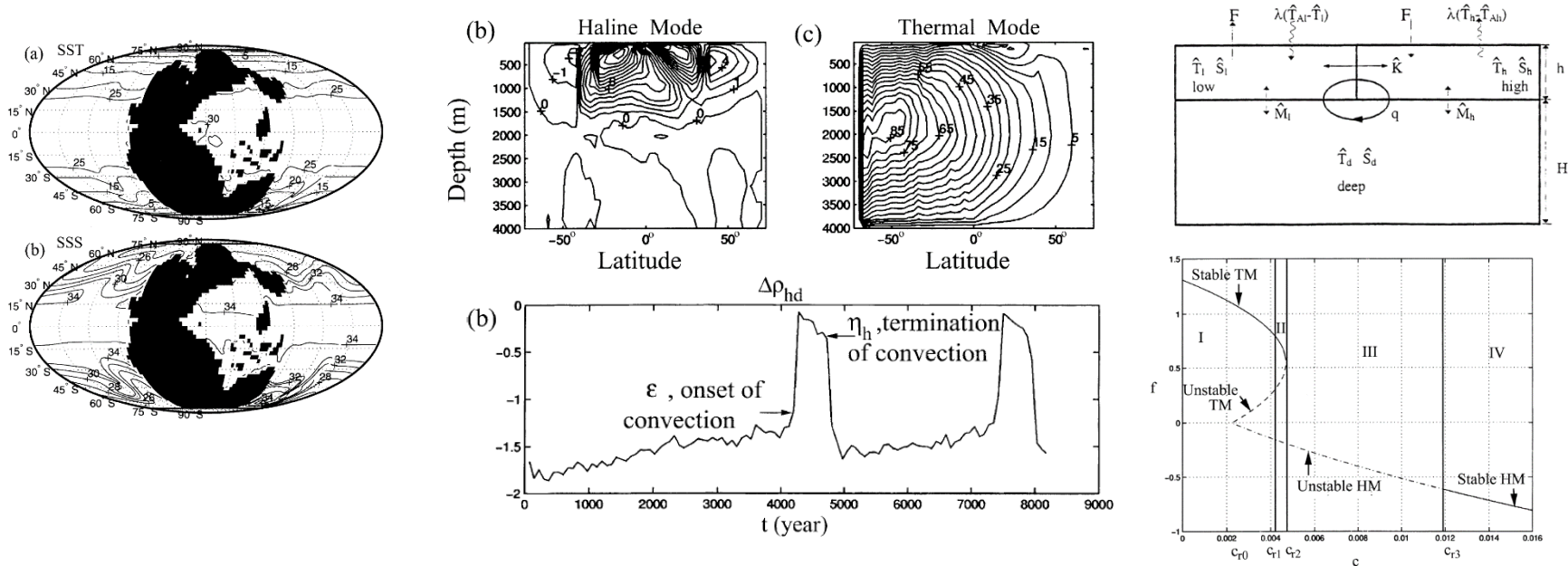

Such oscillations do not appear to occur in the modern ocean, because, apparently, the surface freshwater forcing is not strong enough. Mode switching is more likely to occur, perhaps, during glacial periods in which the freshwater forcing due to ice melting at polar regions is much stronger, or during warm equable paleoclimates such as the late Permian, or mid-Cretaceous in which the buoyancy forcing due to freshwater flux may have been stronger than the air-sea heat flux

Zhang et al. (2002), Mechanism of thermohaline mode switching with application to warm equable climates. JC



Multi-Equilibrium: *Self-Sustained Oscillation*

Lowest-order 3x2-Box and 2D model, internal *Millennial* oscillation

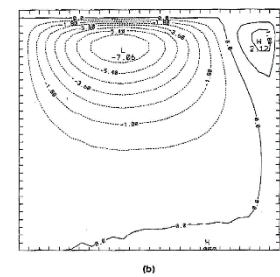
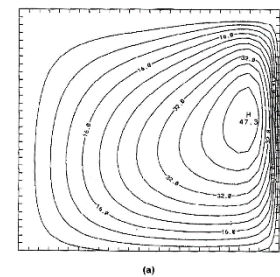
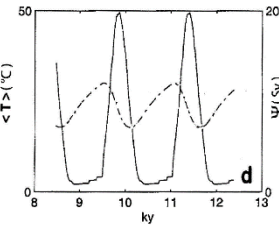
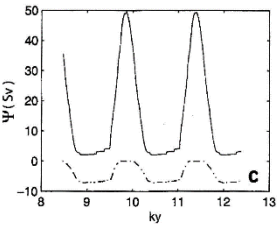
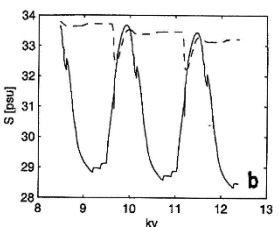
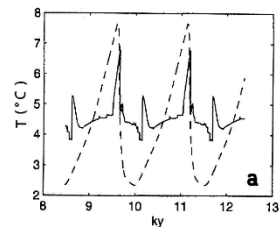
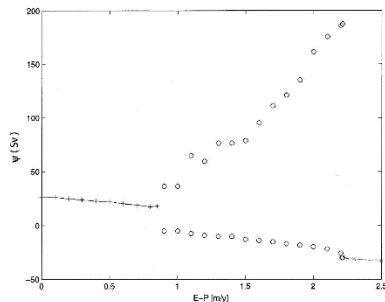
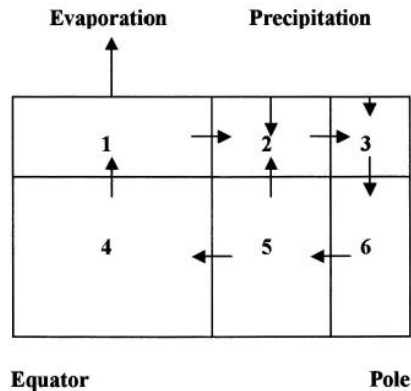

E-P increasing: stable **thermal mode** → **oscillation mode** → steady **haline mode**.

Colin De Verdière, Jelloul and Sevellec (2006), Bifurcation structure of thermohaline millennial oscillations. JC

Beyond Box Model

2-D model and 1-D Howard-Malkus loop model, internal *Centennial* oscillation

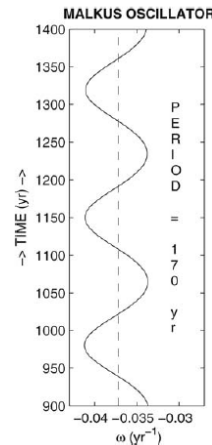
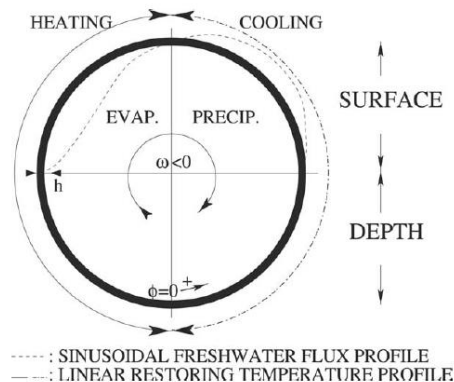
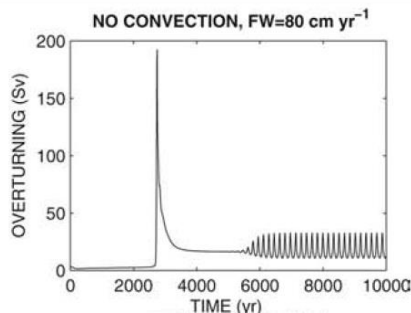
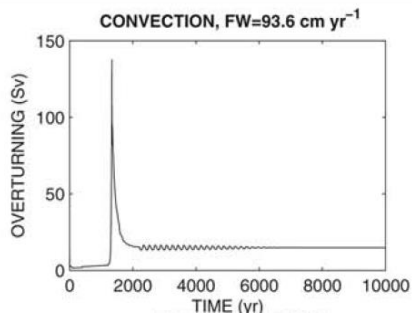

Left: 2-D model; Right: 1-D model of Howard-Malkus loop

Not self-sustained: either strong damped or runaway mode

Nonlinear or linear; convection or no convection

Sévellec et al. (2006), On the mechanism of centennial thermohaline oscillations. J. Marine Research

Beyond Box Model

1-D Howard-Malkus loop model, AMOC *Millennial* regime shifts

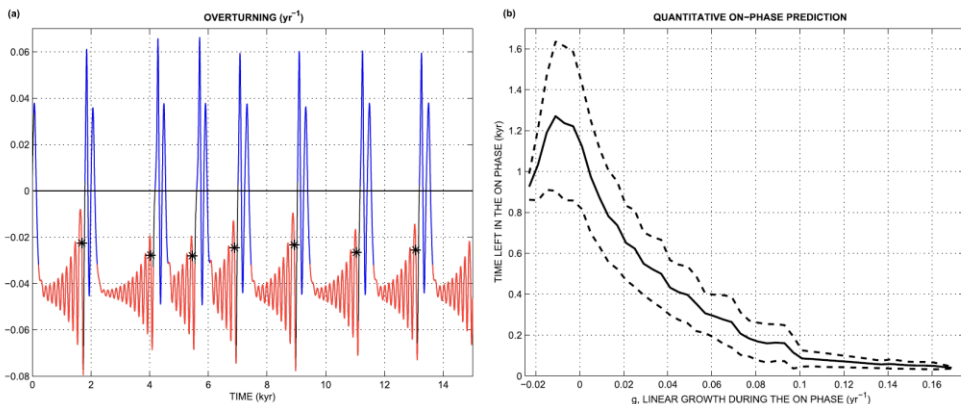
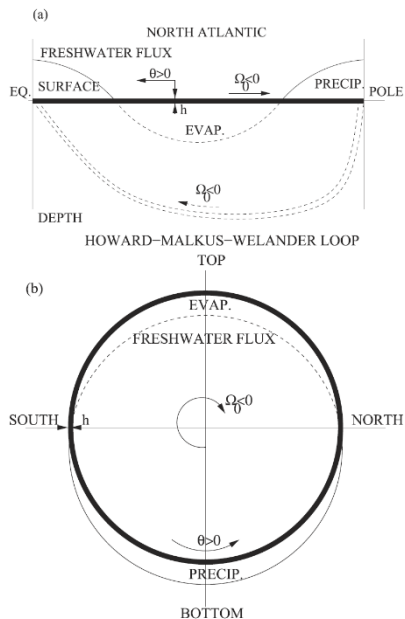

AMOC *Millennial* shift is predictable in this chaotic model

Two predictive indices are defined

Sévellec & Fedorov (2014), Millennial variability in an idealized model: predicting the AMOC regime shifts

Centennial Oscillation in Coupled GCM

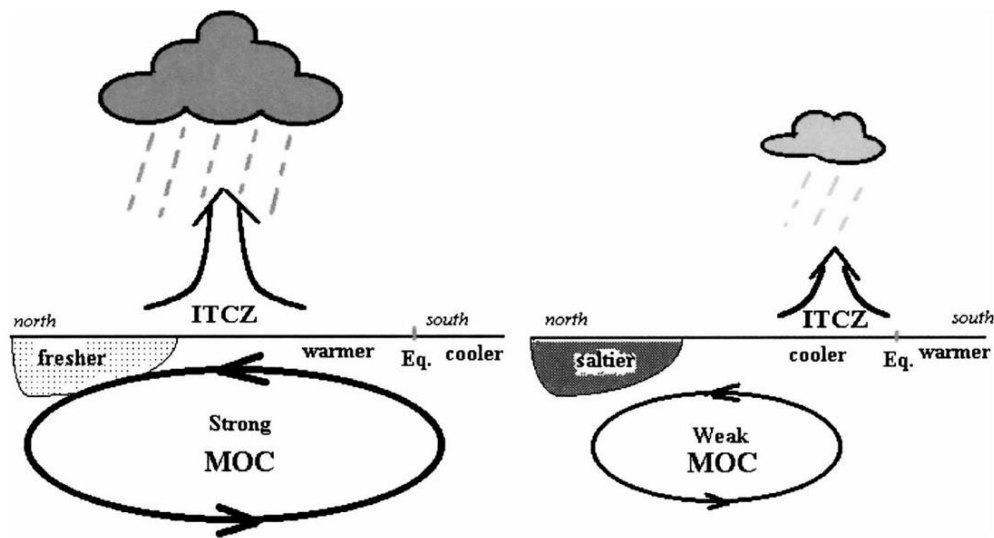

FIG. 16. Schematic of mechanism responsible for centennial THC fluctuation in HadCM3. When the THC is (left) strong ITCZ shifts northward, in response to enhanced SST gradient across equator. Fresh anomalies in the upper-ocean propagate northward and weaken the overturning. This results in the (right) weak phase.

AMOC \uparrow \rightarrow

\rightarrow Northward OHT \uparrow

\rightarrow Cross Eq. Δ SST \uparrow

\rightarrow ITCZ Northward Rain \uparrow

\rightarrow Tropical Salinity \downarrow

\rightarrow Northward S-advection \downarrow

\rightarrow NADW Salinity \downarrow

\rightarrow AMOC \downarrow

Vellinga and Wu (2004), Low-latitude freshwater influence on centennial variability of the Atlantic THC. JC

Previous Theoretical Studies: *Summary*

- **THC: stability, bifurcation and regime shift**
- **Forcing: freshwater or/and stochastic**
- **Transition: thermal mode to haline mode**
- **Self-sustained oscillation: δ -function-like**
- **Not particularly on *Holocene***

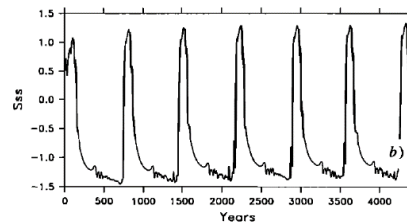
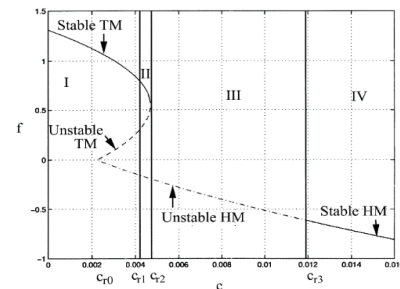

No theory on the multicentennial variability in Holocene!

Climate Variability that *Ocean Matters*

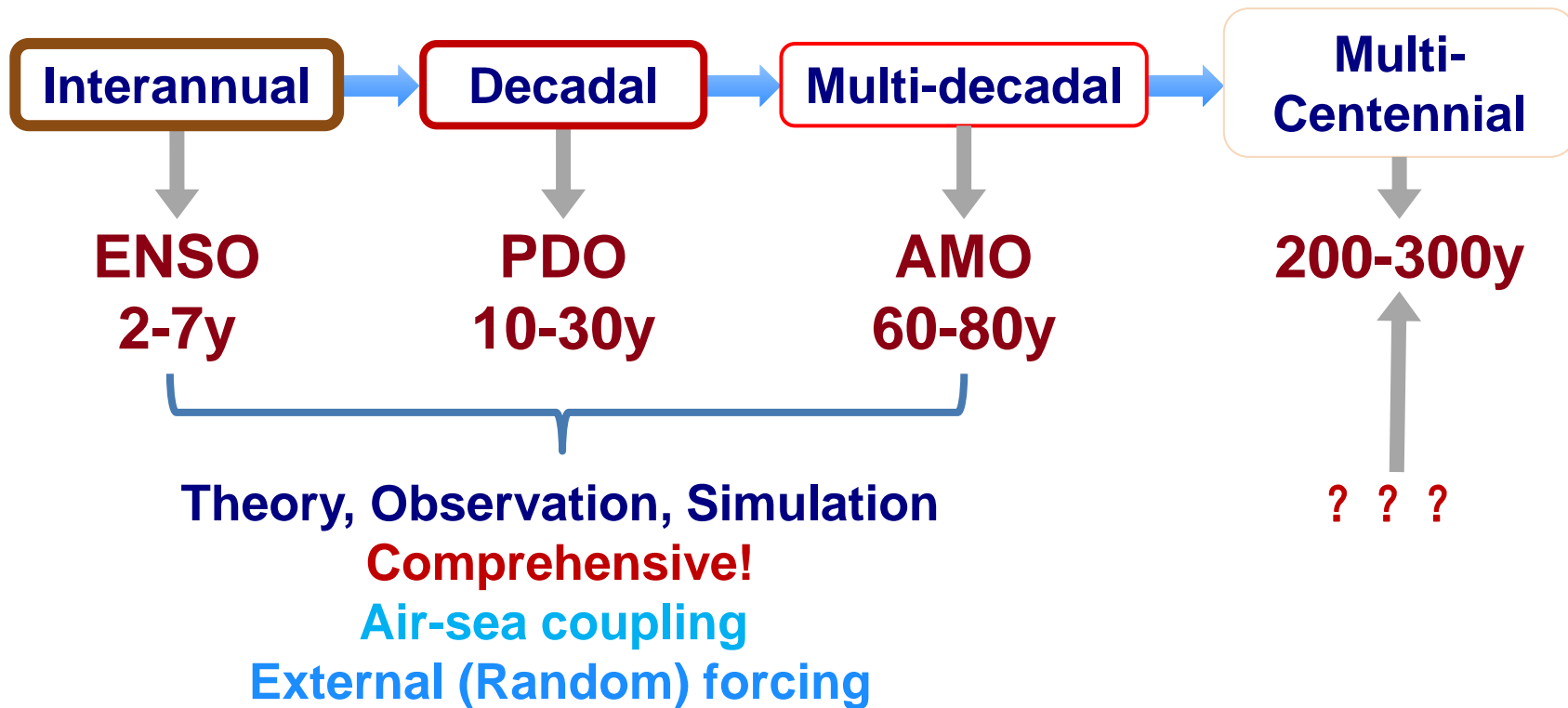

We would like to

Search **Eigen Mode**



Multicentennial Climate Variability in a Stable Climate



Self-Sustained? ? ?

Self-Sustained Oscillation

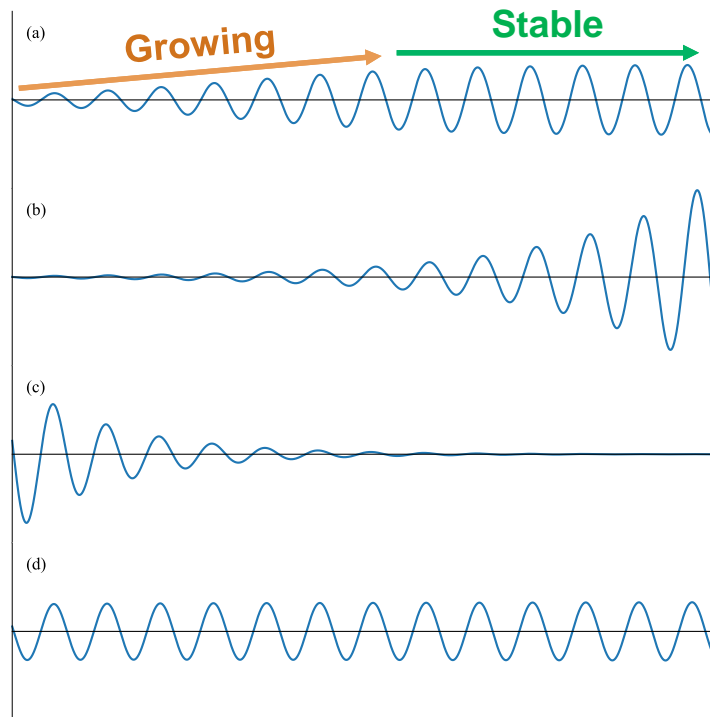

Self-Sustained

Unstable

Damped

Neutral



Contents

1. Motivation
2. Observation
3. Our theory, **Part I: Salinity**
Part II: Temperature
4. Our Modelings

One Hemisphere 4-Box Model

Only *Salinity* Considered

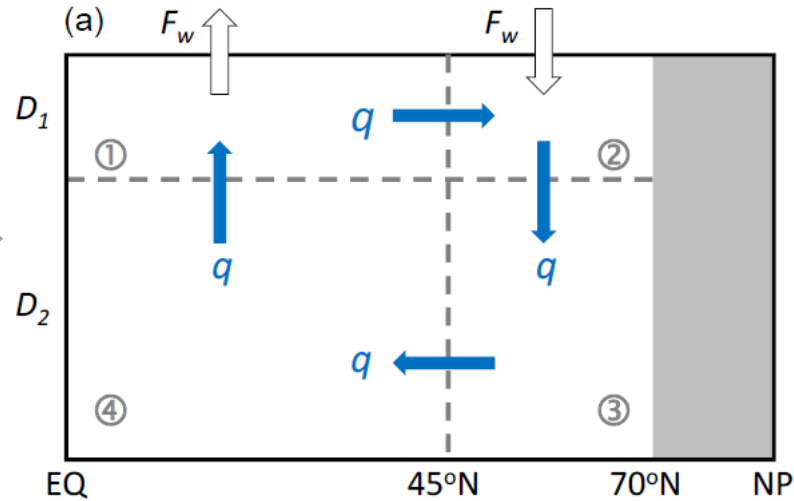

Li and Yang (2022)

One Hemisphere Box Model

Extreme Mixing or Convection

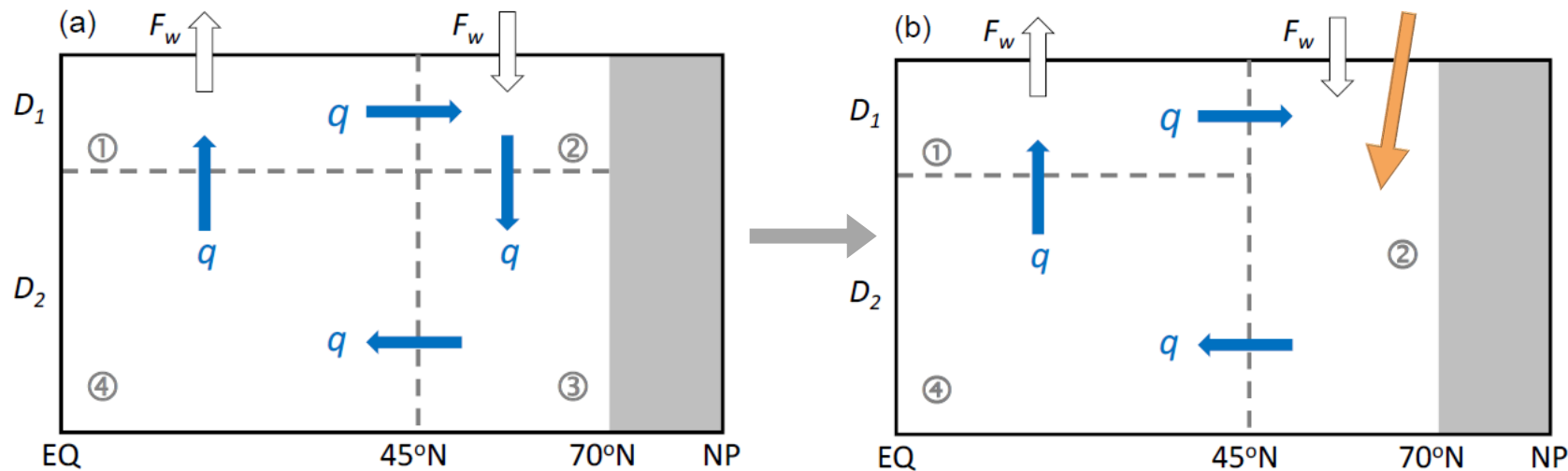

Li and Yang (2022)

One Hemisphere Box Model

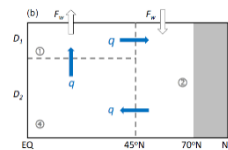
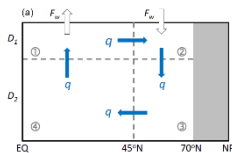

$$V_1 \dot{S}'_1 = q'(\bar{S}_4 - \bar{S}_1) + \bar{q}(S'_4 - S'_1)$$

$$V_2 \dot{S}'_2 = q'(\bar{S}_1 - \bar{S}_2) + \bar{q}(S'_1 - S'_2)$$

$$V_3 \dot{S}'_3 = q'(\bar{S}_2 - \bar{S}_3) + \bar{q}(S'_2 - S'_3)$$

$$V_4 \dot{S}'_4 = q'(\bar{S}_3 - \bar{S}_4) + \bar{q}(S'_3 - S'_4)$$



$$V_1 \dot{S}'_1 = q'(\bar{S}_4 - \bar{S}_1) + \bar{q}(S'_4 - S'_1)$$

$$V_2 \dot{S}'_2 = q'(\bar{S}_1 - \bar{S}_2) + \bar{q}(S'_1 - S'_2)$$

$$V_4 \dot{S}'_4 = q'(\bar{S}_2 - \bar{S}_4) + \bar{q}(S'_2 - S'_4)$$

$$V_1 S'_1 + V_2 S'_2 + V_4 S'_4 = \text{constant}$$

$$\Delta\rho' = \rho_0\beta[\delta(S'_2 - S'_1) + (1 - \delta)(S'_3 - S'_4)], \text{ and } \delta = \frac{V_1}{V_1+V_4} = \frac{V_2}{V_2+V_3} = \frac{D_1}{D}$$

$$q' = \lambda\Delta\rho' = \lambda\rho_0\beta[S'_2 - \delta S'_1 - (1 - \delta)S'_4], \text{ and } \delta = \frac{V_1}{V_1+V_4} = \frac{D_1}{D}$$

Li and Yang (2022)



AMOC sensitivity to Density

A linear closure method:

$$\text{AMOC} \longrightarrow q' = \lambda \Delta \rho' \longleftarrow \text{Meridional Density Gradient}$$

λ : linear closure parameter, *critical* to the oscillatory behavior
Controlling the AMOC change in response to the meridional density gradient change

Parameter for the Box Model and Eigenvalues

4-box **Growing** Oscillatory mode ($0.31 \pm 5.83i$) 0 -37.4

3-box **Damped** Oscillatory mode ($-0.29 \pm 5.78i$)

Symbol	Physical meaning	Value
V_2	Volume of upper subpolar Atlantic box	$2.8 \times 10^{15} \text{ m}^3$
V_1, V_3, V_4	Volumes of upper tropical Atlantic, lower subpolar Atlantic, and lower tropical Atlantic boxes, respectively	$5V_2, 7V_2, 35V_2$
D_1, D_2, D	Depths of upper box, lower box, and total, respectively	500, 3500, 4000 m
$\bar{S}_1, \bar{S}_2, \bar{S}_3, \bar{S}_4$	Reference salinity values of the four ocean boxes	36, 33.5, 33.5, 33.5 psu
\bar{q}	Equilibrium AMOC strength	$10 \text{ Sv} (10^6 \text{ m}^3 \text{ s}^{-1})$
F_w	Total virtual salt flux	$2.50 \times 10^7 \text{ psu m}^3 \text{ s}^{-1}$
β	Haline contraction coefficient	$7.61 \times 10^{-4} \text{ psu}^{-1}$
ρ_0	Reference density	$1.00 \times 10^3 \text{ kg m}^{-3}$
λ	Linear closure coefficient	$12 \text{ Sv kg}^{-1} \text{ m}^{-3}$



Theoretical Solution to 3-Box Model

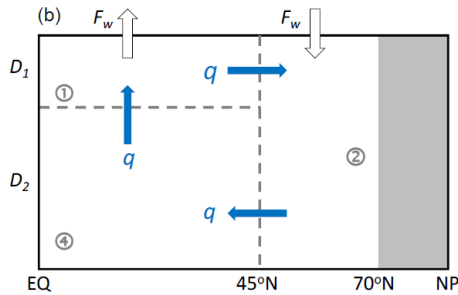

Li and Yang (2022)

$$\omega = \frac{1}{2} \left[(C_2 M - C_3) \pm \sqrt{(C_2 M - C_3)^2 - 4 C_2 C_4 (1 - M)} \right]$$

Stability Condition

$$M \leq \min\left(\frac{C_3}{C_2}, 1\right)$$

Oscillation Condition

$$M_1 < M < \min(M_2, 1)$$

$$M_1 = \frac{C_3 - 2C_4}{C_2} - \frac{2}{C_2} \sqrt{C_4^2 + C_4(C_2 - C_3)}, \quad M_2 = \frac{C_3 - 2C_4}{C_2} + \frac{2}{C_2} \sqrt{C_4^2 + C_4(C_2 - C_3)}.$$

$$M = \frac{\rho d}{\bar{q}} \lambda: \text{nondimensional form of } \lambda$$



Stability Condition for 3-Box Model

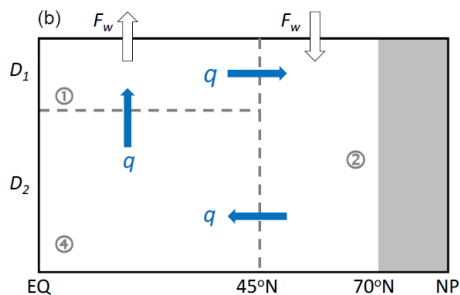

Li and Yang (2022)

$$\lambda < \lambda_c \equiv \frac{\bar{q}^2}{\rho_0 \beta \bar{F}_w} \left[1 + \frac{\delta_2}{\delta(1 - \delta)} \right]$$

λ_c : the critical linear closure parameter when $Re[\omega] = 0$, determined by \bar{q} , \bar{F}_w and basin geometry. A stronger \bar{F}_w and a weaker \bar{q} give a smaller λ_c , implying higher possibility for an unstable oscillation, since the background meridional salinity gradient in this situation will be stronger. In addition, salinity anomalies also spend more time at the surface with a weaker \bar{q} . This will also make the system more unstable, and this is why we have a quadratic term of \bar{q} . A bigger volume of the subpolar ocean (δ_2) gives a larger λ_c , implying a higher probability for a stable oscillation. In this situation, the salinity difference anomaly between subpolar and tropical upper oceans is larger under the same q' , and thus the mean advection of salinity anomaly is stronger, which would result in a stronger stabilizing effect.

Oscillatory Modes with λ

Self-Sustained Regime

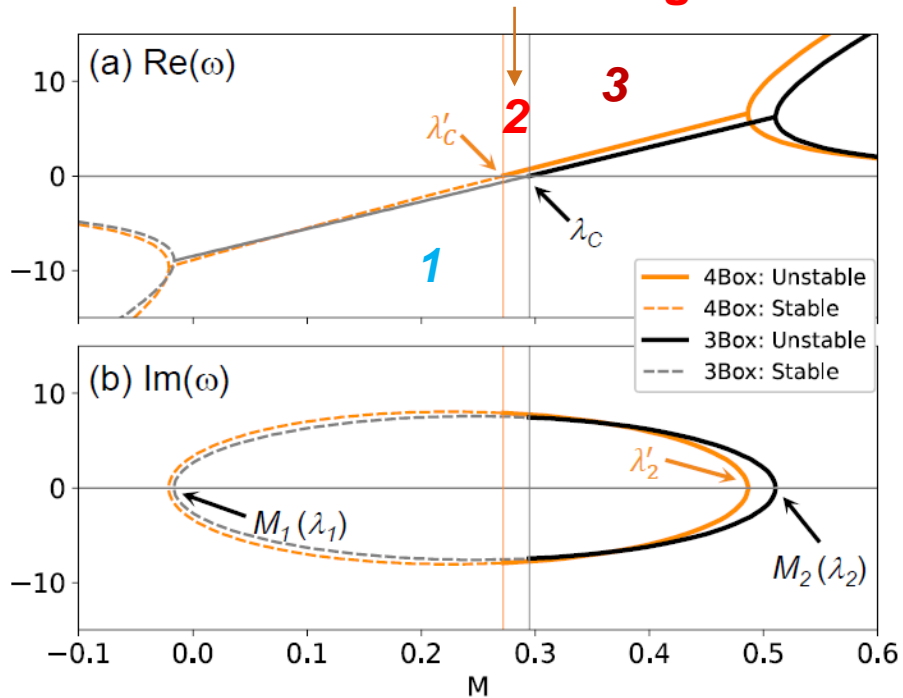

Li and Yang (2022)

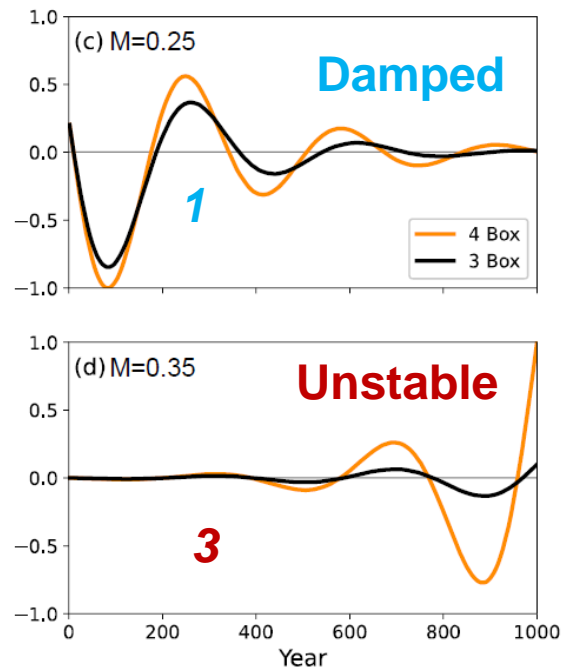

How to *Realize a Self-Sustained* Oscillation?

An Enhanced Mixing or Convection

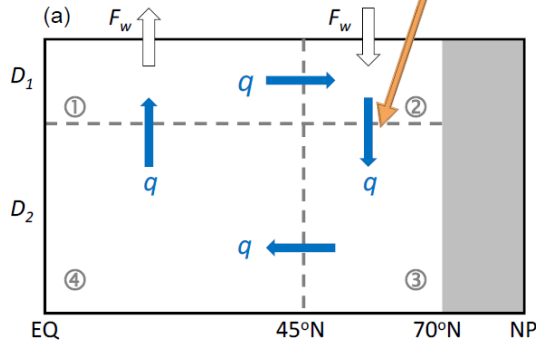

$$V_2 \dot{S}'_2 = q'(\bar{S}_1 - \bar{S}_2) + \bar{q}(S'_1 - S'_2) - k_m(S'_2 - S'_3)$$

$$V_3 \dot{S}'_3 = \bar{q}(S'_2 - S'_3) + k_m(S'_2 - S'_3)$$

$k_m = \kappa q'^2$: Proportional to AMOC anomaly

What *Enhanced* Mixing or Convection?

Eulerian-mean

Eddy-induced

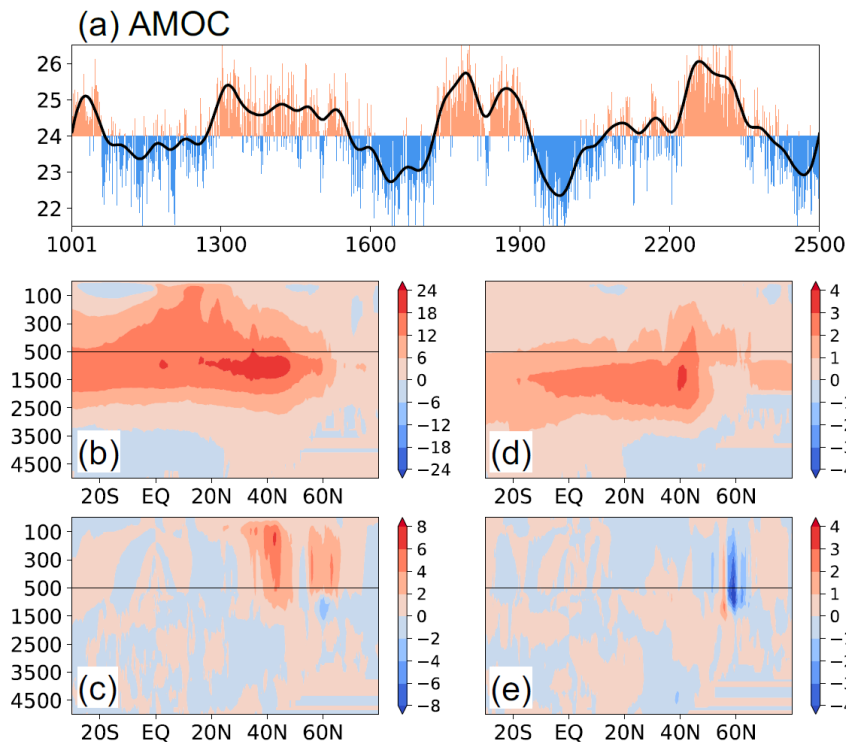

Euler AMOC ↑



Vertical diffusion ↑

Eddy AMOC ↑



Vertical mixing ↑



What *Enhanced* Mixing or Convection?

Stratification in Subpolar Atlantic

$$AMOC \sim \sigma' \sim S' \sim -T'$$

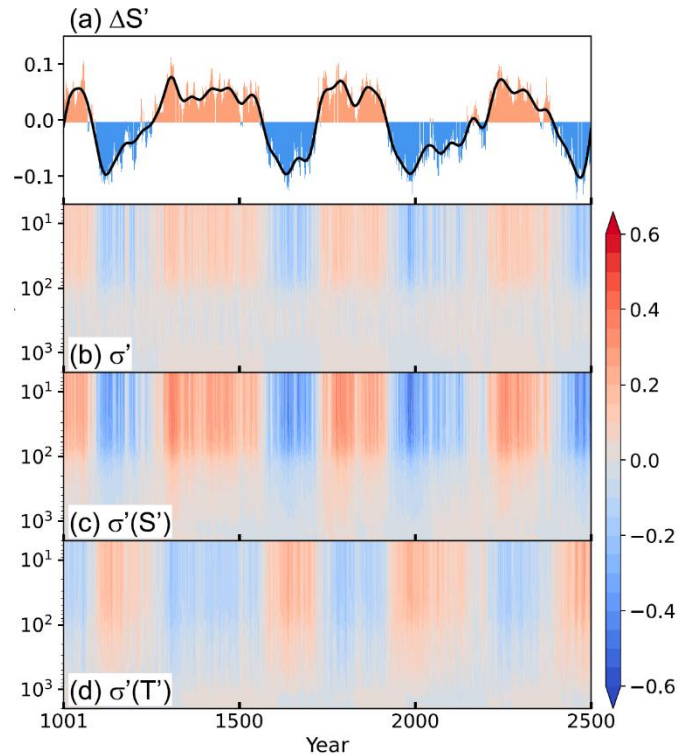

What *Enhanced* Mixing or Convection?

Mixing $\sim \Delta S'$

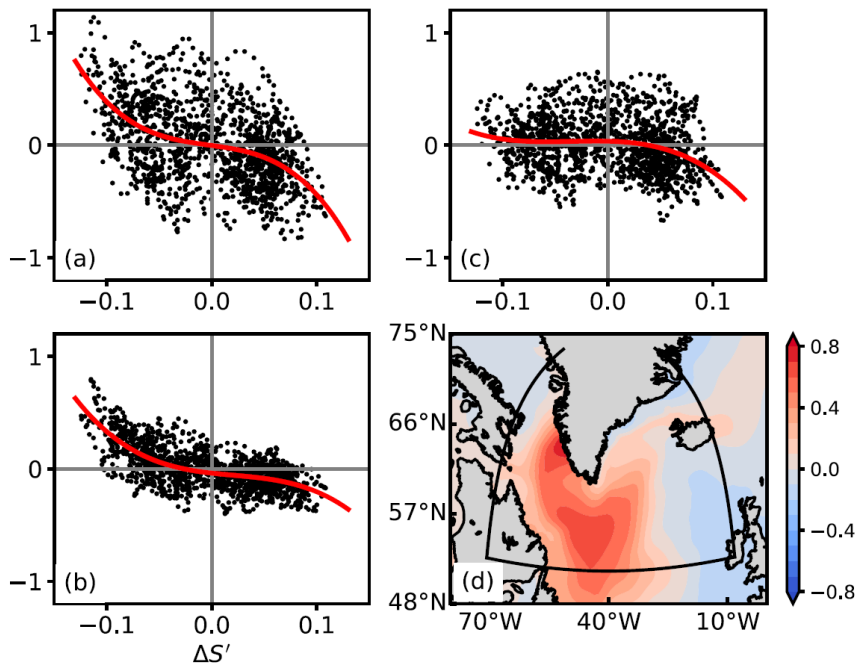

$$F_{\text{mixing}} \sim -(\Delta S')^3 \sim -(q')^2 \Delta S' \sim -k_m \Delta S'$$

Self-Sustained Oscillation

Without k_m

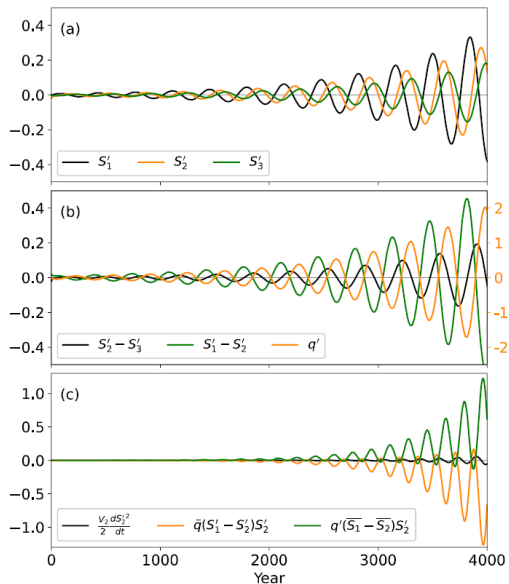

With k_m

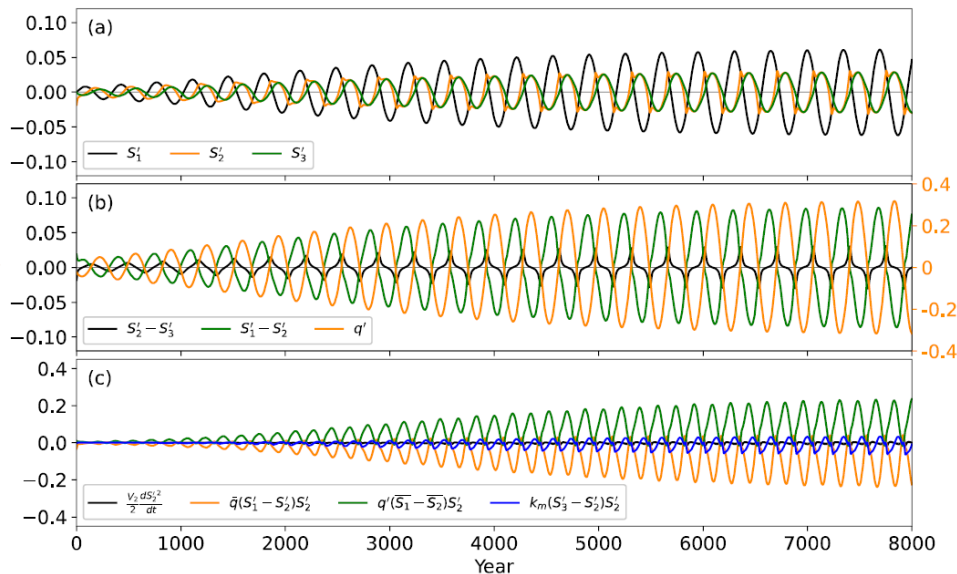

Can be only realized in 4-Box model

Li and Yang (2022)



Self-Sustained Oscillation: *Physics*

$$q'(S'_2) \sim \left\{ \begin{array}{l} q'(\overline{S}_1 - \overline{S}_2) \quad \text{Local Term} \\ \quad \text{Positive Feedback} \\ \overline{q}(S'_1 - S'_2) \quad \text{Advection Term} \\ \quad \text{Negative Feedback} \\ -k_m(S'_2 - S'_3) \quad \text{Enhanced Mixing} \\ \quad \text{Negative Feedback} \end{array} \right.$$

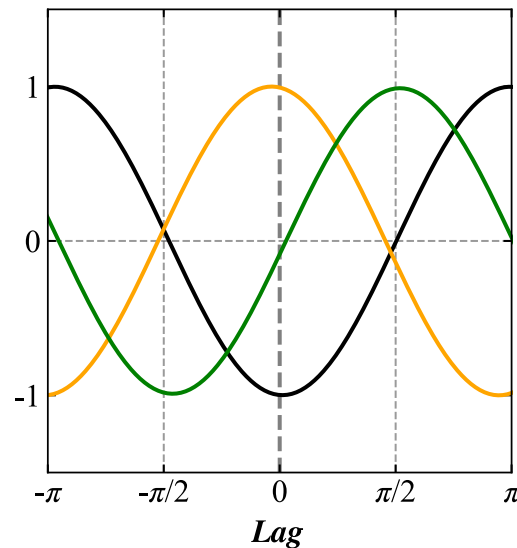

Li and Yang (2022); Yang et al. (2022)

Self-Sustained Oscillation in Ocean Space

Damped
Regime

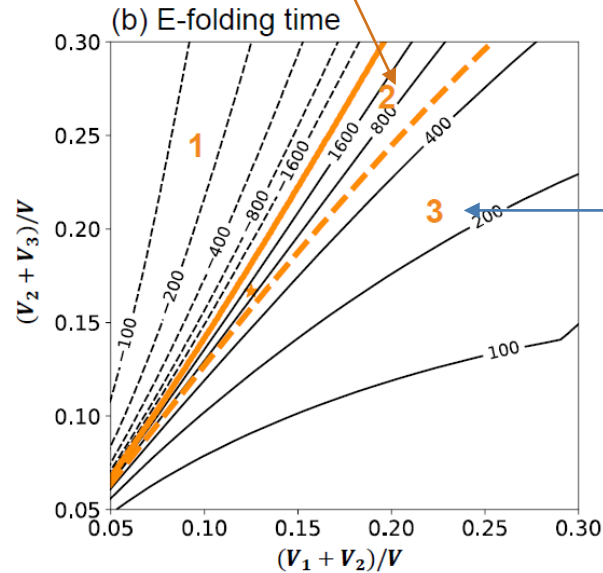
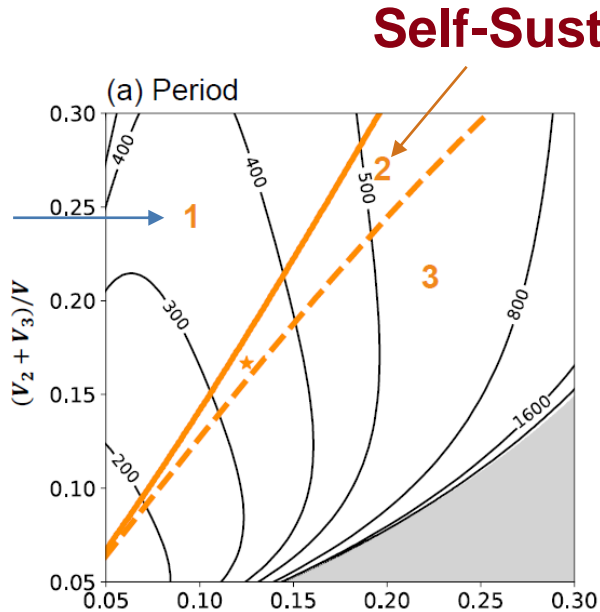

Unstable
Regime

Li and Yang (2022)

Nonlinear Advection Effect

$$q'(S'_1 - S'_2)$$

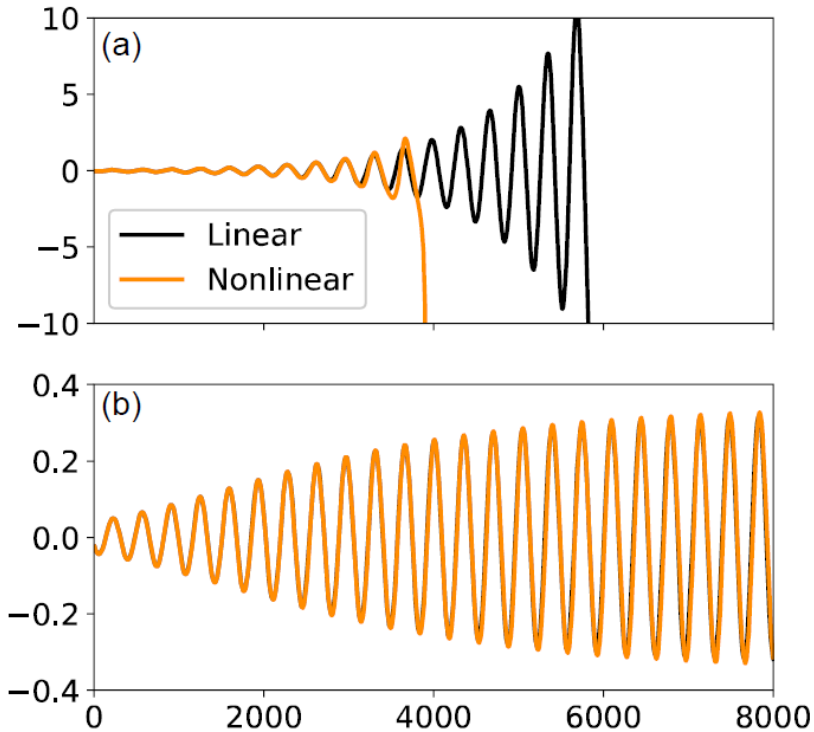

Li and Yang (2022)



Self-Sustained Oscillation Excited by *Stochastic Forcing*

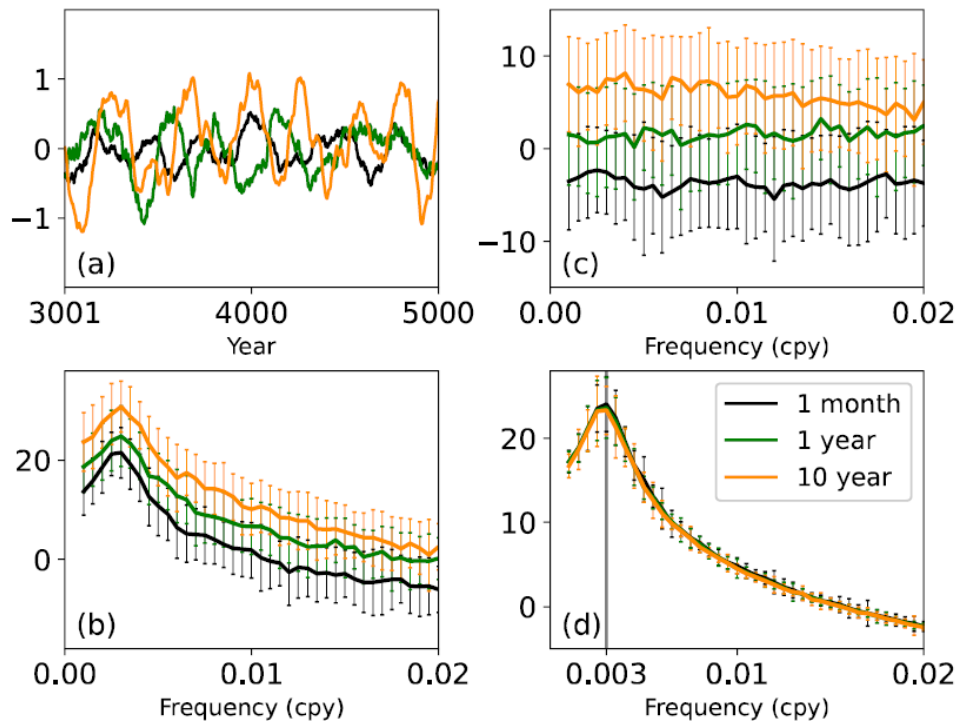

Li and Yang (2022)



Contents

1. Motivation
2. Observation
3. Out theory, Part I: Salinity
Part II: Temperature
4. Modeling – CGCM or OGCM

One Hemisphere 4-Box Model

Both *Temperature* and *Salinity* Considered

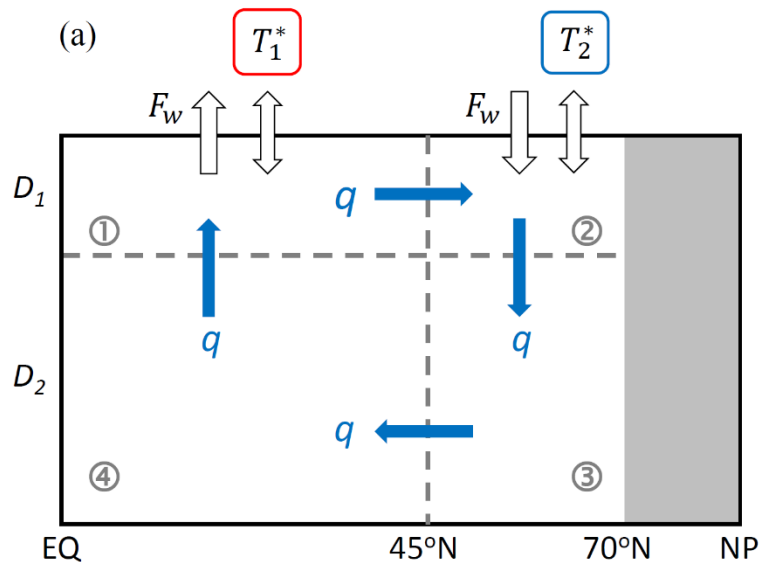

Yang et al. (2022)



One Hemisphere 4-Box Model

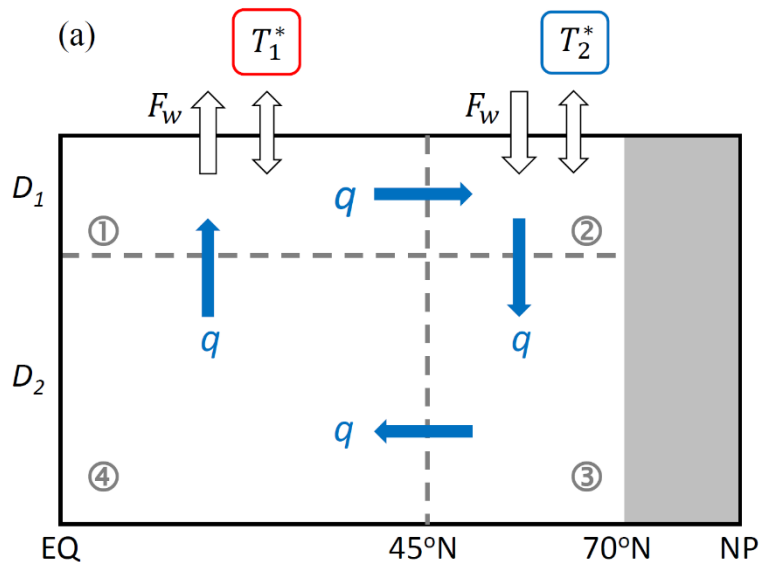

Extreme Mixing or Convection

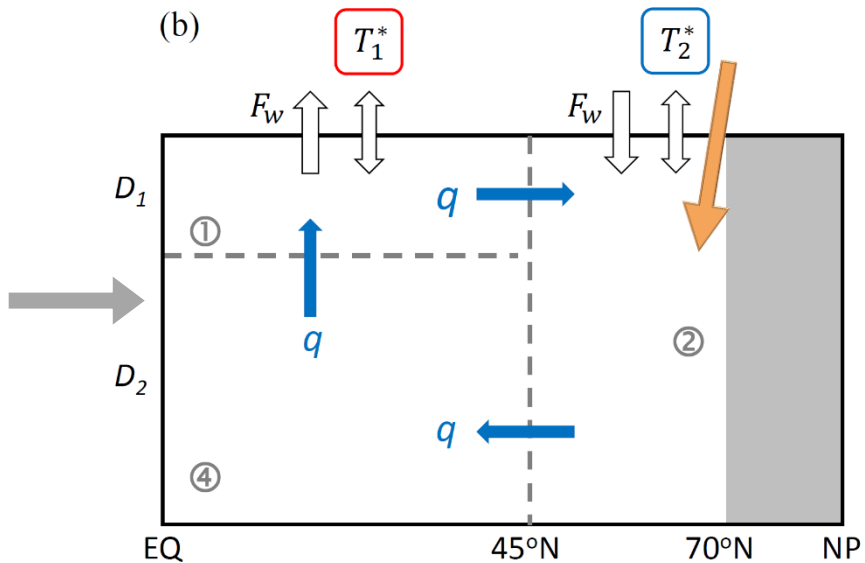

Li and Yang (2022)



One Hemisphere 4-Box Model

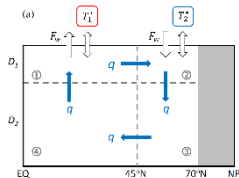

$$V_1 \dot{T}_1 = q(T_4 - T_1) + V_1 \tau(T_1^* - T_1)$$

$$V_2 \dot{T}_2 = q(T_1 - T_2) + V_2 \tau(T_2^* - T_2)$$

$$V_3 \dot{T}_3 = q(T_2 - T_3)$$

$$V_4 \dot{T}_4 = q(T_3 - T_4)$$

$$V_1 \dot{S}_1 = q(S_4 - S_1) + F_w$$

$$V_2 \dot{S}_2 = q(S_1 - S_2) - F_w$$

$$V_3 \dot{S}_3 = q(S_2 - S_3)$$

$$V_4 \dot{S}_4 = q(S_3 - S_4)$$



$$\bar{T}_1 = T_1^* - \frac{\bar{q}V_2(T_1^* - T_2^*)}{\bar{q}(V_1 + V_2) + V_1 V_2 \tau}, \quad \bar{T}_2 = \frac{V_1 T_1^* + V_2 T_2^* - V_1 \bar{T}_1}{V_2} = \bar{T}_3 = \bar{T}_4$$

$$\bar{S}_1 = F_w / \bar{q} + \bar{S}_2, \quad \bar{S}_2 = \bar{S}_3 = \bar{S}_4$$

$$1/\tau = \frac{\rho_w c \Delta z A}{\kappa_0 A} = \frac{\rho_w c \Delta z}{\kappa_0}$$

$$q = \bar{q} + q'$$

$$q' = q'_T + q'_S = \lambda \Delta \rho'_T + \lambda \Delta \rho'_S = \lambda \Delta \rho'$$

$$\Delta \rho'_T = -\rho_0 \alpha [\delta(T'_2 - T'_1) + (1 - \delta)(T'_3 - T'_4)]$$

$$\Delta \rho'_S = \rho_0 \beta [\delta(S'_2 - S'_1) + (1 - \delta)(S'_3 - S'_4)]$$

$$\delta = \frac{V_1}{V_1 + V_4} = \frac{V_2}{V_2 + V_3} = \frac{D_1}{D}$$

Yang et al. (2022)



AMOC sensitivity to Density

A linear closure method:

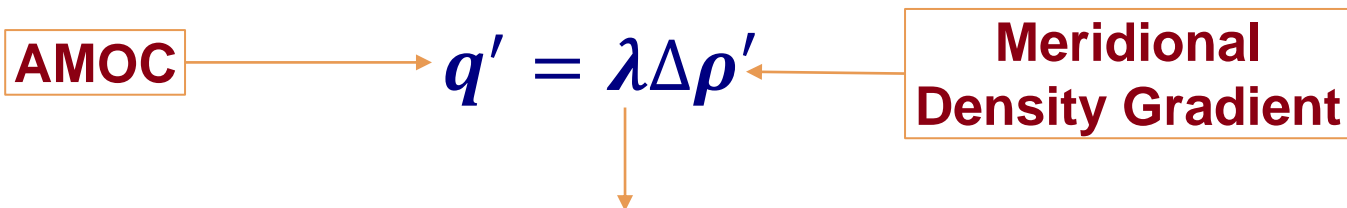

λ : linear closure parameter, **critical** to the oscillatory behavior
Controlling the AMOC change in response to the meridional density gradient change

Eigenvalues: 4TS vs 4S

4S-box	<i>Growing</i> Oscillatory mode ($0.31 \pm 5.83i$)	0	-37.4
		\updownarrow \updownarrow	
4TS-box	<i>Damped</i> Oscillatory mode ($-0.55 \pm 6.59i$)	0	-37.4, -366 -366, -324 -5.28, -0.78

Oscillatory Modes with λ

Temperature
makes
system
more
damped!

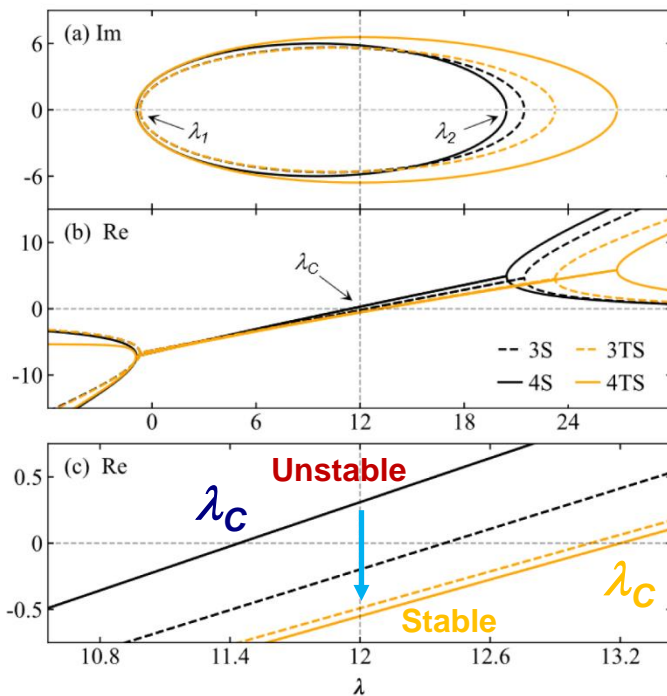

Bigger
 λ_c
requires
bigger
sensitivity!

Yang et al. (2022)



Oscillation with T and S

Temperature turn
unstable into *damped*!

Positive
restoring feedback

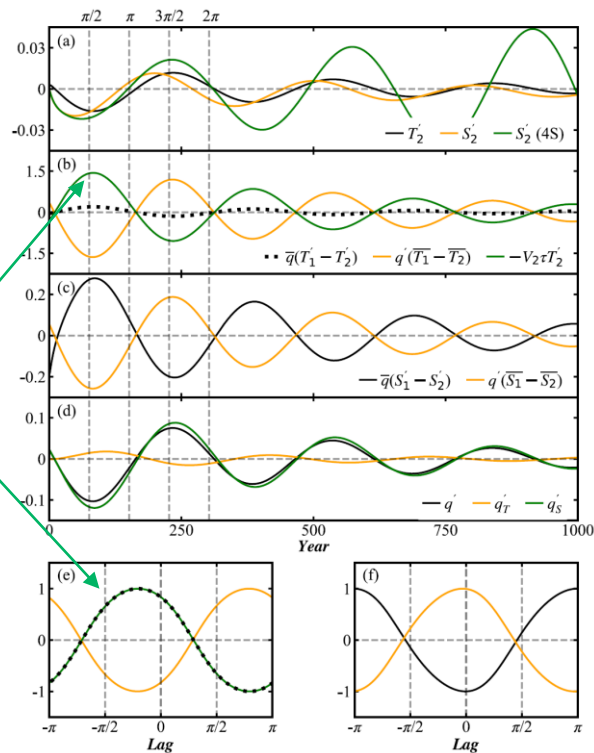

Salinity
dominates AMOC

Yang et al. (2022)



Role of *Restoring* Temperature

Restoring
feedback
Contained!

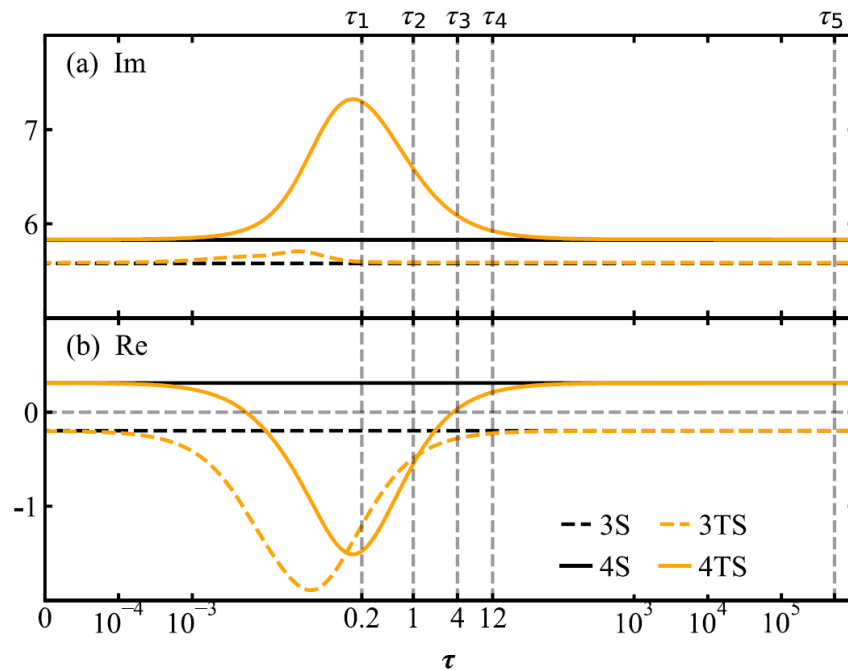

Yang et al. (2022)

Self-sustained Oscillation With Enhanced Mixing

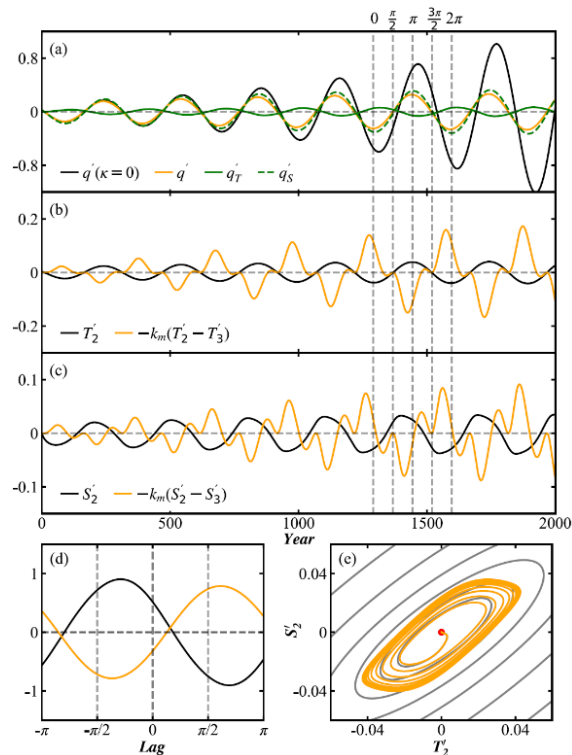

Yang et al. (2022)

Self-sustained Oscillation With Nonlinear Closure

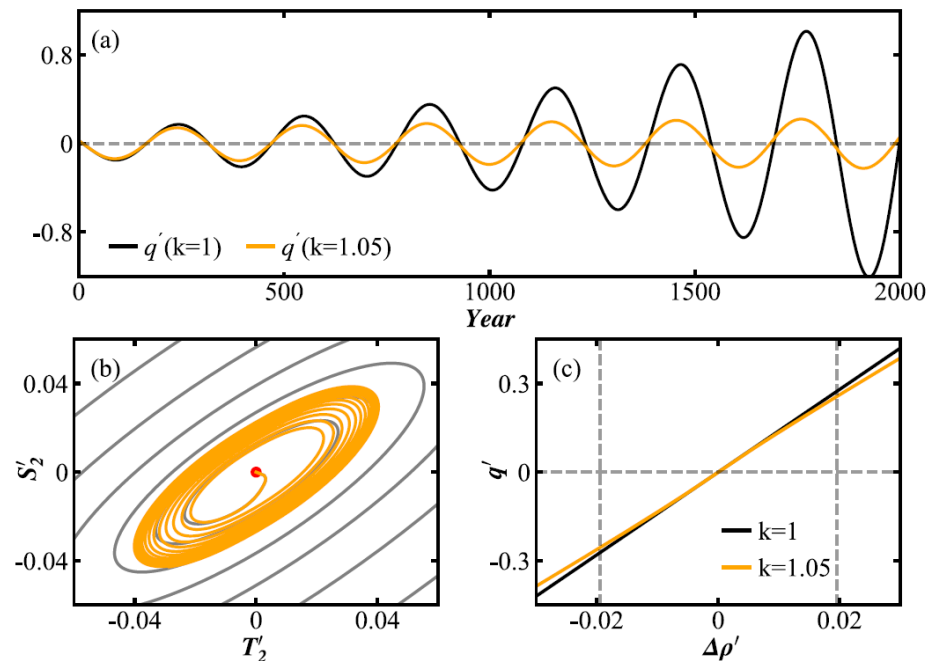

A tiny nonlinearity
makes the system
Self-sustained!

$$q' = \begin{cases} \lambda\rho_{cri} \left[k \left(\left[\frac{\Delta\rho'}{\rho_{cri}} \right]^{\frac{1}{k}} - 1 \right) + 1 \right], & \text{if } \Delta\rho' > \rho_{cri} \\ \lambda\Delta\rho' & \text{if } -\rho_{cri} < \Delta\rho' < \rho_{cri} \\ -\lambda\rho_{cri} \left[k \left(\left[-\frac{\Delta\rho'}{\rho_{cri}} \right]^{\frac{1}{k}} - 1 \right) + 1 \right], & \text{if } \Delta\rho' < -\rho_{cri} \end{cases}$$

Yang et al. (2022)

Self-Sustained Oscillation in Ocean Space

Self-Sustained Regime

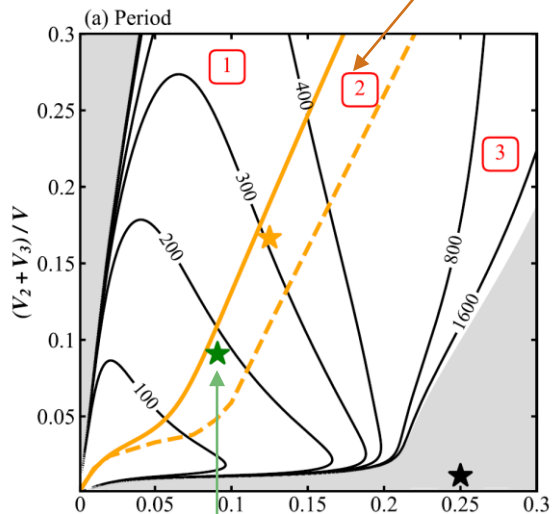

Griffies and Tziperman (1995)

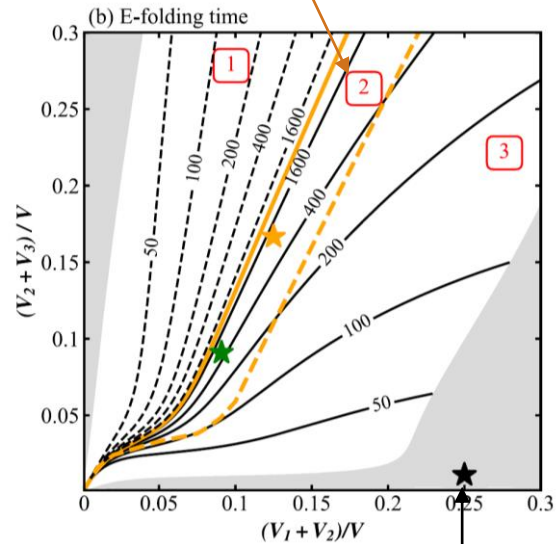

Rivin and Tziperman (1997)

Yang et al. (2022)

Contents

1. Motivation
2. Observation
3. Theory
4. **Modeling – CGCM or OGCM**

Centennial-Millennial Variabilities

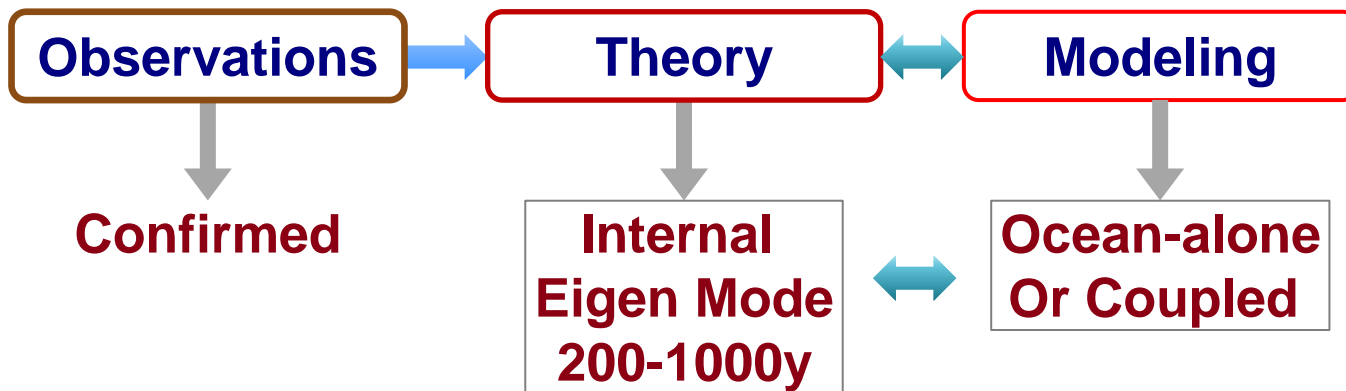

最新研究：耦合模式结果

EC-Earth3.0模式结果

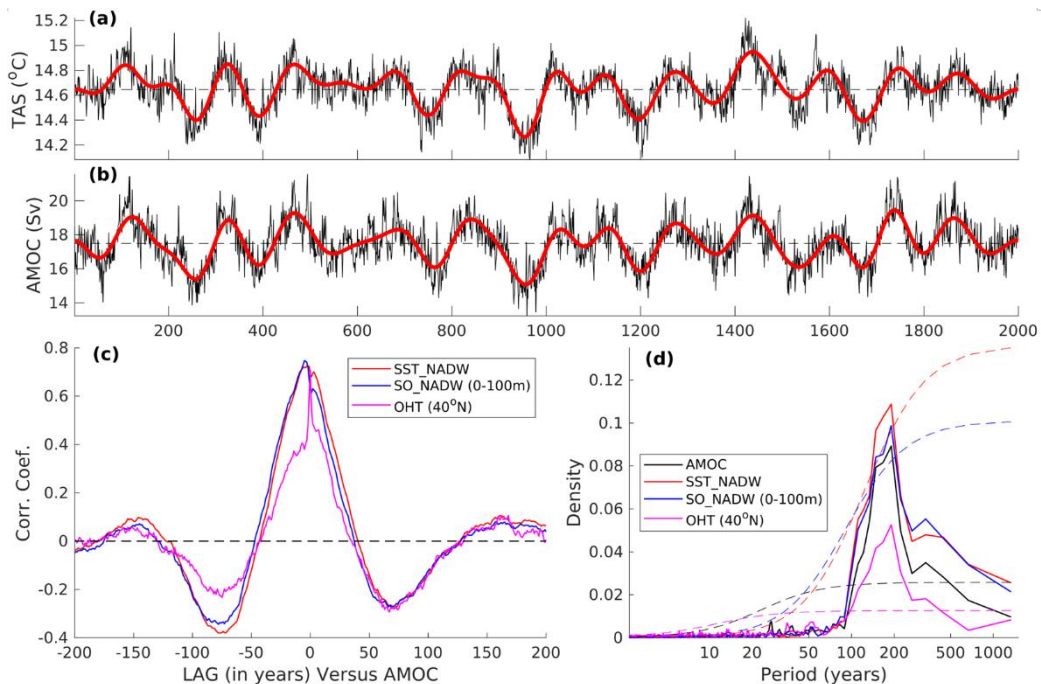

Cao et al., 2022: The role of Arctic Ocean in modulating the multi-centennial variability of Atlantic meridional overturning circulation. GRL, submitted.



最新研究：耦合模式结果

EC-Earth3.0模式结果

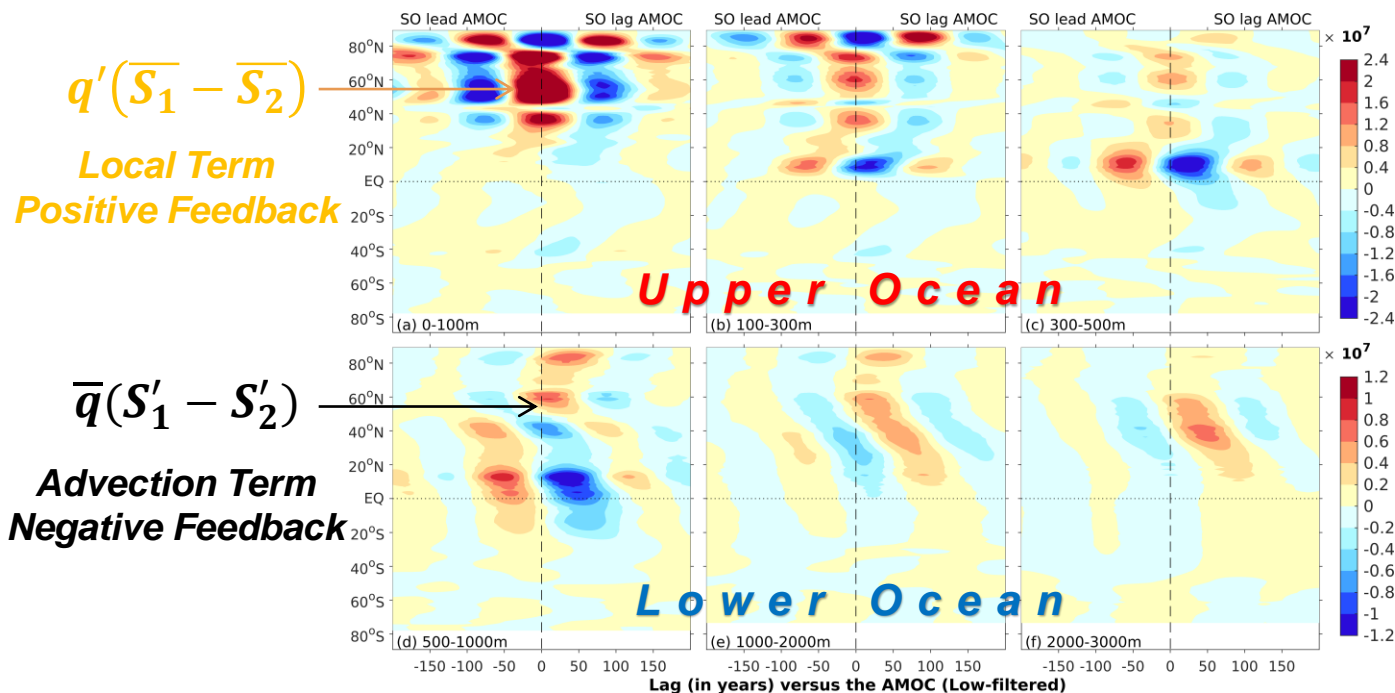

Cao et al., 2022: The role of Arctic Ocean in modulating the multi-centennial variability of Atlantic meridional overturning circulation. GRL, submitted.

最新研究：耦合模式结果

EC-Earth3.0模式结果

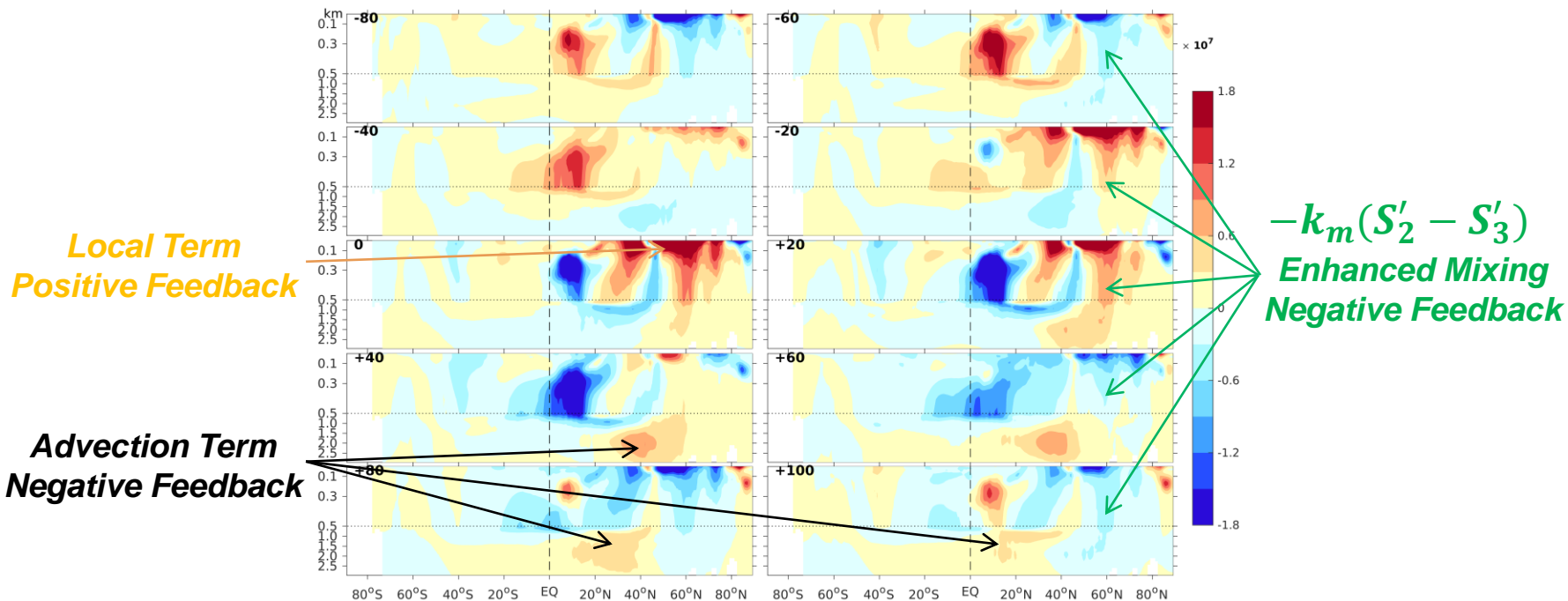

Cao et al., 2022: The role of Arctic Ocean in modulating the multi-centennial variability of Atlantic meridional overturning circulation. GRL, submitted.



最新研究：耦合模式结果

CESM1.0模式结果

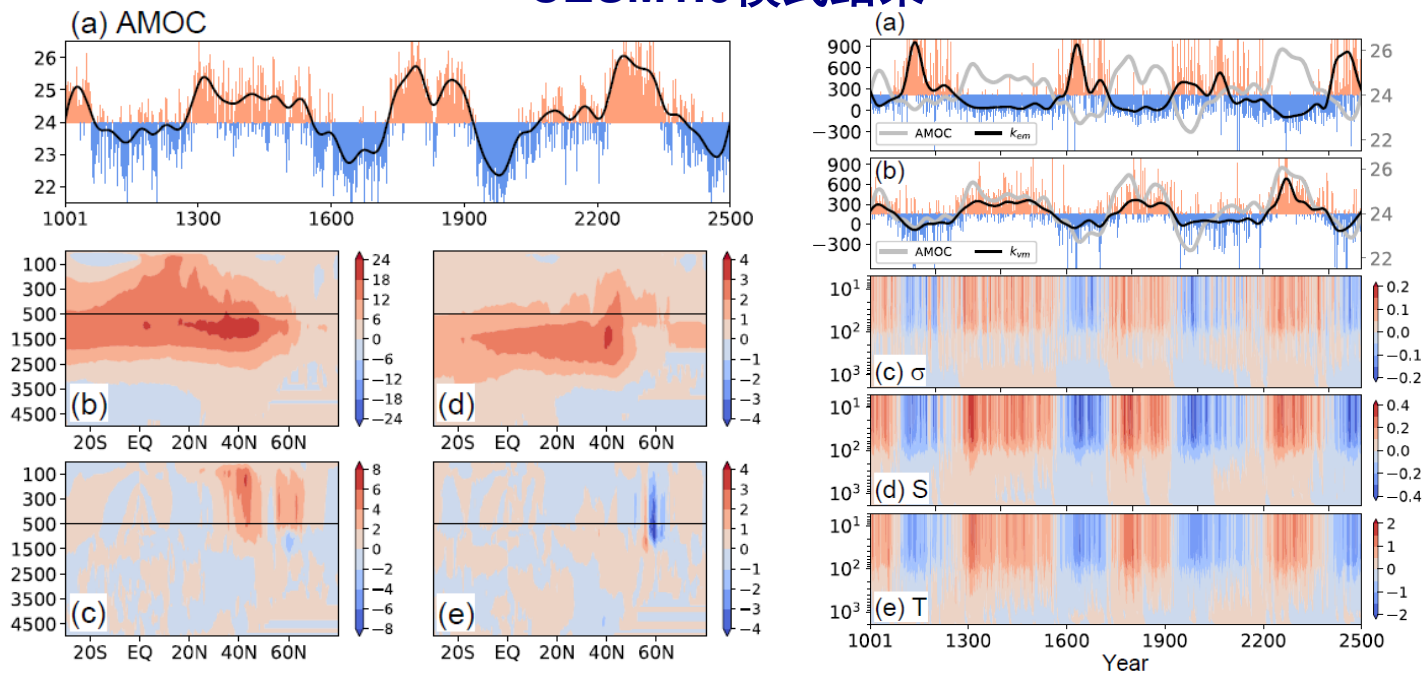

李洋, 2022: 博士论文



最新研究：耦合模式结果

CESM1.0模式结果：Salinity on AMOC

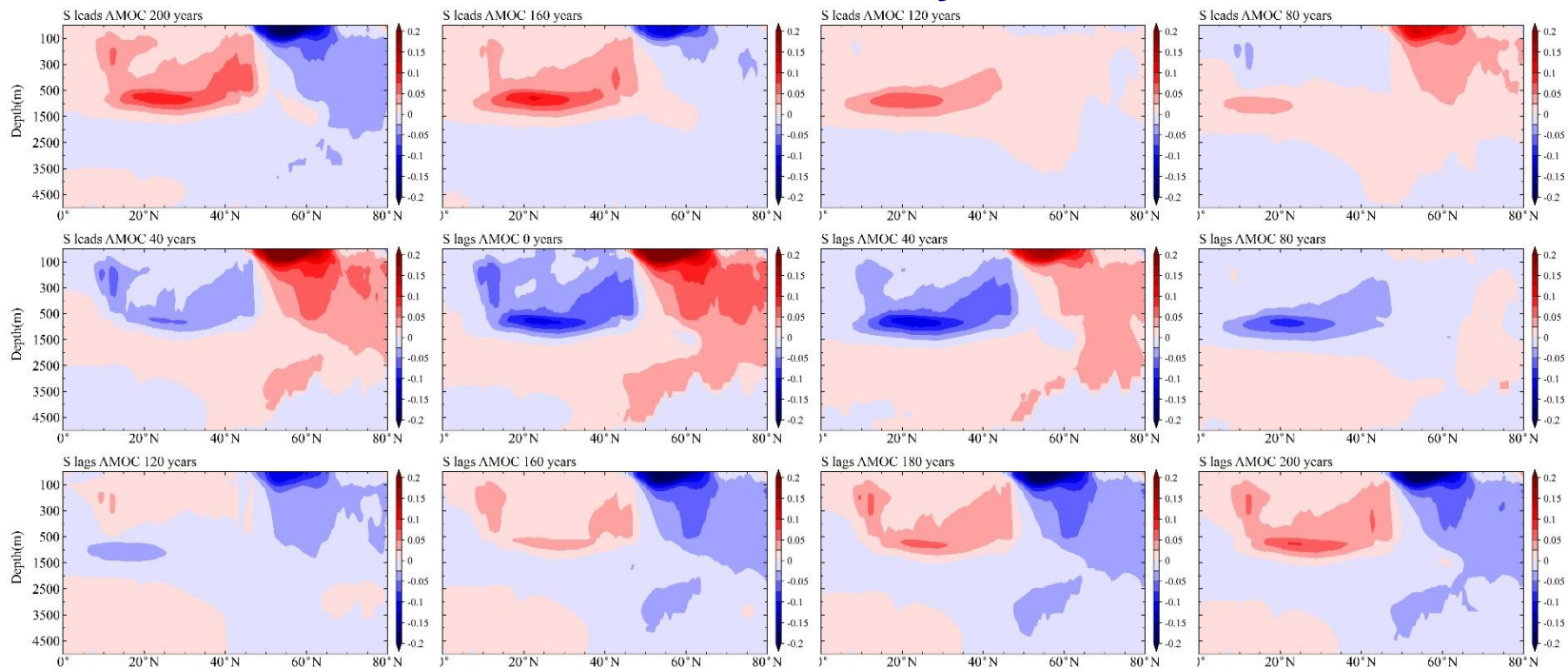

最新研究：耦合模式结果

CESM1.0模式结果：Temperature on AMOC

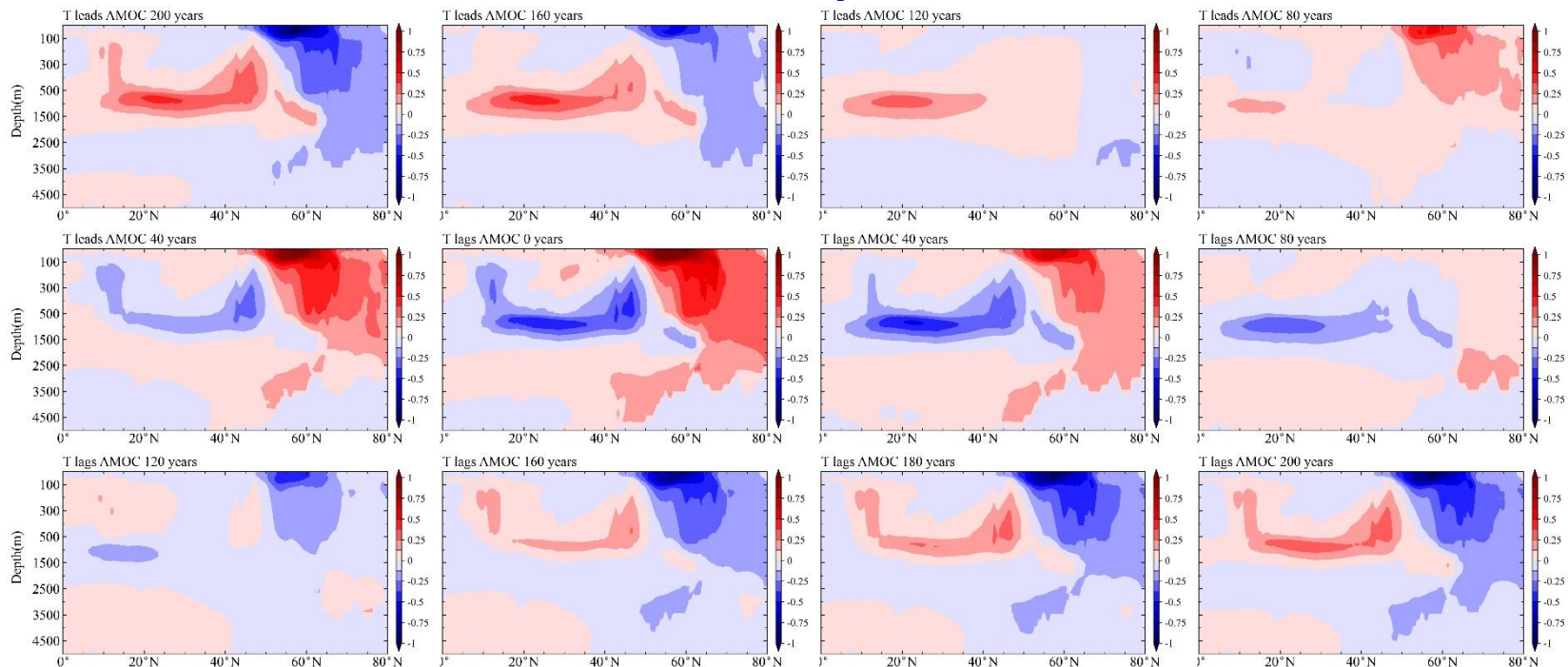

最新研究：耦合模式结果

CESM1.0模式结果：Density on AMOC

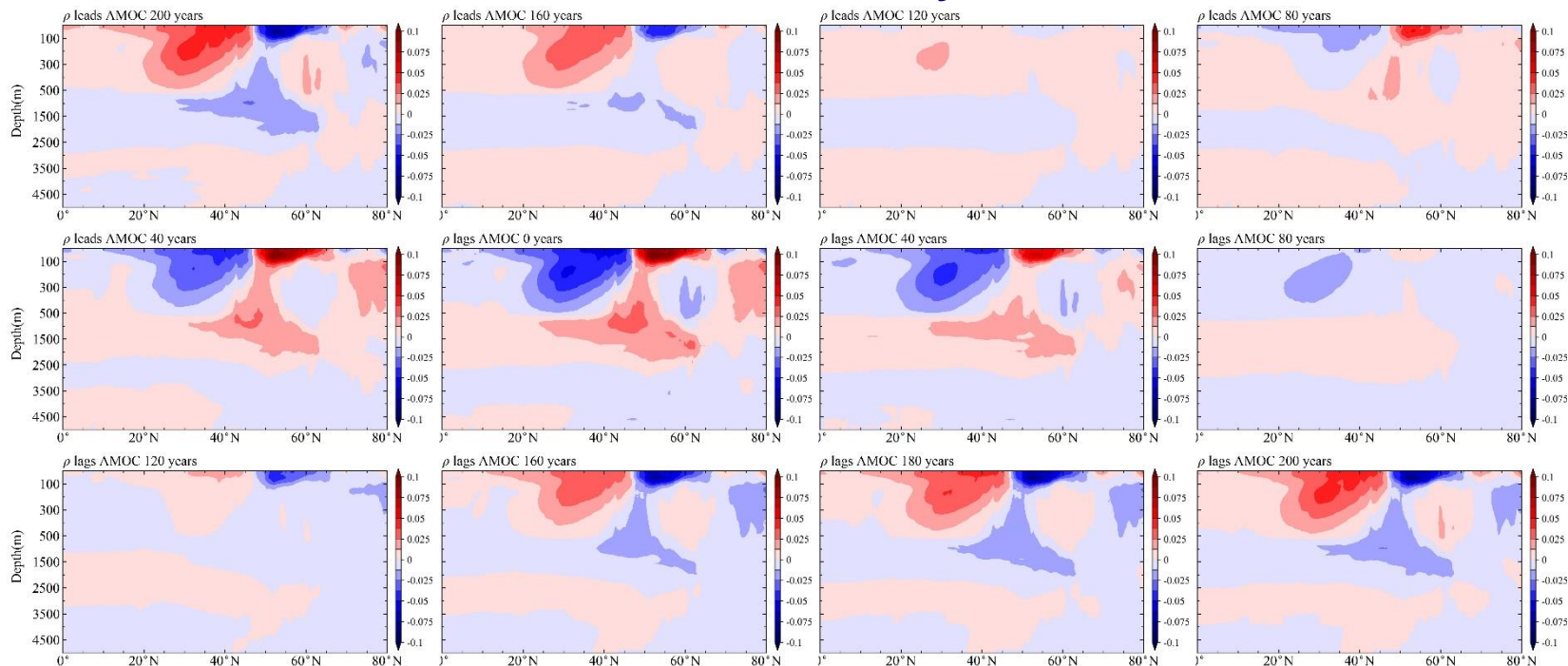

Multicentennial Climate Variability

A 10-year journey to decipher the mystery

- Eigen Mode: **Identified!**
- Physics: **Disclosed!**
- Self-sustained: **Realized!**
- Salinity change matters
- Advection-feedback process dominates

Li and Yang, 2022: A theory of self-sustained multicentennial oscillation of the AMOC. , *J. Climate*
Yang et al., 2023: A theory for self-sustained multicentennial oscillation of the AMOC. Part II: Role of Temperature. *J. Climate*. *Accepted*

<https://corp.fudan.edu.cn/>



LaCOAS
北京大学气候与海-气实验室

Thanks

